

OFERTAS 2022.02



EG-AWG002

Sistema de alarma Wifi+GSM
Batería de emergencia GSM.
Ampliable hasta
60 sensores



* Tarjeta SIM no incluida.



SCAN ME

139 €



GSM con SIM
y/o WIFI

Control desde
el teléfono
móvil

CA-PRO50SILENC

1,5 HP - 8 Bar
150 Lt/min
1.400 r.p.m.
Sin aceite
50 Lt.

59 dB
Silencioso



SCAN ME

199 €

CE-TITAN200AC/DC

230 V. 50/60 Hz.
5 - 200A
Tensión de salida en vacío: 67V.
Ø electrodo MMA 1.6 - 4 mm.
Ø electrodo tungsteno 1.0 -3.25 mm.
Factor de marcha TIG al 60%: 200A
IP23
Incluye antorcha tig
y pinza de masa.

Aluminio



SCAN ME

999 €



W690 FLEXIO

Depósito: 1800 ml
(pintura para pared)
800 ml (lacas y barnices)
630 W.
Para trabajos grandes:
15m²/6 min
Manguera 3,5 mt.
WG-2370368

CLICK & PAINT

Regulación de
caudal de aire
variable
Extensión
adicional
WG-2361756



SCAN ME

157 €



WAGNER

Profesionales trabajando para Profesionales

CA-PRO6SILENT

1 HP - 8 Bar
110 Lt/min
1.400 r.p.m.
Sin aceite
6 Lt.

62 dB
Silencioso



149€

CA-PRO12SILENT

1 HP - 8 Bar
115 Lt/min
1.400 r.p.m.
Sin aceite
12 Lt.

62 dB
Silencioso



145€

CA-PRO25SILENC

1,5 HP - 8 Bar
150 Lt/min
1.400 r.p.m.
Sin aceite
24 Lt.

59 dB
Silencioso



159€

CA-PRO50SILENC

1,5 HP - 8 Bar
150 Lt/min
1.400 r.p.m.
Sin aceite
50 Lt.

59 dB
Silencioso



199€

CA-PRO40SILENC

2 HP - 8 Bar
196 Lt/min
1.200 r.p.m.
Sin aceite
40 Lt.

65 dB
Silencioso



259€

CA-PRO50SVT

Compresor
150 Lt/min.
115 PSI - 8 BAR
1,5 HP
1.400 r.p.m.
Sin aceite
50 Lt.

59 dB
Silencioso



199€

CA-PRO80SILENT

3 HP - 8 Bar - 350 Lt/min
1.200 r.p.m. - Sin aceite - 80 Lt.

68 dB
Silencioso



499€

CA-C330/03PRO

3 HP - 10 Bar
330 Lt/min
1.400 r.p.m.
3 Lt.

Trabajo continuo



799€

CA-POWERAIR

Inflador (550 W)
Soplador (380 W - 720 Lt/min)
16 V - Display digital
5 boquillas.

Bateria



49€

CA-AIR230/12

230/12 V. - 7 Bar
20 Lt/min



39€

CA-TORBELLINO

0.25 HP
3.2 Bar
60 Lt/min

Membrana



95€

CA-PRO7N

230 V. - 1,5 HP
8 Bar - 160 Lt/min
Sin aceite
6 Lt.

Asa de transporte



119€

CA-PRO25 / CA-PRO55

230 V. - 2 HP
8 Bar - 195 Lt/min
25 Lt./50 Lt.



CA-PRO25

139€

CA-PRO55

175€

CA-PRO24XT

230 V. - 2,5 HP
8 Bar - 205 Lt/min
24 Lt.



165€

3

CA-PRO50

230 V. - 2,5 HP
8 Bar - 205 Lt/min
50 Lt.



199€

CA-PRO26NG

230 V. - 2,5 HP
9 Bar - 246 Lt/min
Sin aceite
24 Lt.

Sin mantenimiento
Motor inducción



165€

CA-PRO51NG

230 V. - 2,5 HP
9 Bar - 246 Lt/min
Sin aceite
50 Lt.

Sin mantenimiento
Motor inducción



199€

CA-PRO25VX

230 V. - 3 HP
8 Bar - 340 Lt/min
25 Lt.

Cabezal
en "V"



269 €

CA-PRO50VX

230 V. - 3 HP
8 Bar - 340 Lt/min
50 Lt.

Cabezal
en "V"



279 €

CA-PRO100VX

230 V. - 3 HP
8 Bar - 340 Lt/min
100 Lt.

Cabezal
en "V"



409 €

CA-AB25/3M

230 V. - 3 HP
10 Bar - 330 Lt/min
24 Lt.



555 €

CA-AB25/3MGT

230 V. - 3 HP
10 Bar - 330 Lt/min
24 Lt.

Especial
gotelé



699 €

CA-AB25/415MGT

230 V. - 3 HP
10 Bar - 400 Lt/min
24 Lt.

TOP
LINE



799 €

CA-AB50/3M

230 V. - 3 HP
10 Bar - 330 Lt/min
50 Lt.



567 €

CA-AB100/3M

230 V. - 3 HP
10 Bar - 330 Lt/min
100 Lt.



599 €

CA-AB100/3T

400 V. - 3 HP
10 Bar - 330 Lt/min
100 Lt.



599 €

CA-AB100- 515M
230 V. - 4 HP
10 Bar - 510 Lt/min
100 Lt.

**TOP
LINE**



819€

CA-AB200/3M
230 V. - 3 HP
10 Bar - 330 Lt/min
200 Lt.



745€

CA-AB200/3T
400 V. - 3 HP
10 Bar - 330 Lt/min
200 Lt.



745€

CA-AB200/515M
230 V. - 4 HP
10 Bar - 510 Lt/min
200 Lt.

**TOP
LINE**



1.029€

CA-AB200/515
380 V. - 4 HP
10 Bar - 510 Lt/min
200 Lt.



1.029€

CA-AB300/525TF
380 V. - 5,5 HP
11 Bar - 550 Lt/min
270 Lt.



1.313€

CA-AB300-598
380 V. - 5,5 HP
11 Bar - 600 Lt/min
270 Lt.

**TOP
LINE**



1.550€

CA-AB500/7.5T
380 V. - 7,5 HP
11 Bar - 830 Lt/min
500 Lt.



1.982€

CA-AB500/10T
380 V. - 10 HP
11 Bar
1.070 Lt/min
500 Lt.

**TOP
LINE**

Estrella
triángulo



2.877€

CA-AB500/10
380 V. - 10 HP
11 Bar
1070 Lt/min
500 Lt.



2.227€

CA-S1520
5 HP - 10 Bar
275 Lt/min
76 dB
20 Lt.



1.125 €

Motor gasolina



CA-AGRI65
5,5 HP - 10 Bar
540 Lt/min
76 dB
11+11 Lt.



2.320€

Motor gasolina



CA-AGRI90/678
9 HP - 10 Bar
670 Lt/min
76 dB
17+17 Lt.

Motor gasolina



2.499€

CA-AGRI90-998
13 HP - 10 Bar
1.090 Lt/min
76 dB
17+17 Lt.

Motor gasolina



3.350€

CA-AGRI75DIESEL
7,7 HP - 10 Bar
650 Lt/min
76 dB
17+17 Lt.

Motor diesel



3.699€

6

CA-ABT500-1716
380 V. - 7,5 + 7,5 HP
11 Bar
1.776 Lt/min
500 Lt.

BAJO PEDIDO



CONSULTAR PRECIO

CA-ABT900-1996
380 V. - 10 + 10 HP
11 Bar
2.140 Lt/min
900 Lt.

BAJO PEDIDO



CONSULTAR PRECIO

CABEZAS COMPRESORAS

Cabezas compresoras de doble pistón. Bloque de cilindro en hierro fundido.

MODELO	HP	LT/MIN	KG.	OFERTA
CA-AB268	2	250	15	155 €
CA-AB348	3	350	15	165 €
CA-AB360	3	360	15	209 €
CA1127420217	3	350	15	159 €
CA-AB515	4	510	24	279 €
CA-AB525	5,5	550	24	375 €
CA-AB598	5,5	598	30	499 €
CA-AB808	7,5	800	32	569 €
CA-AB858	7,5	650	35	609 €
CA-AB998	10	1069	38	659 €



MOTORES ELECTRICOS

Motores para compresores de aire con polea.

MODELO	DESCRIPCIÓN	KG.	OFERTA
CA1124150082	230V- 2 HP	17	149 €
CA1124150077	230V- 3 HP	19	229 €
CA1124150031	380V- 3 HP	19	239 €
CA1124150018	380V- 4 HP	28	289 €
CA1124150024	380V- 5,5 HP	30	389 €
CA1124150091	380V- 7,5 HP	35	399 €
CA1124150083	380V- 10 HP	40	439 €



CA-ACEITE1LT

Aceite aceite especial para compresores de pistón. 1 Lt. SAE 30/40



Pistón

11 €

CA-ACEITE5LCP46

Aceite aceite especial para compresores de tornillo. 5 Lt. SAE 10/20



Tornillo

7

36 €

CA-ACEITE5LT

Aceite aceite especial para compresores de pistón. 5 Lt. SAE 30/40



Pistón

35 €

CA-901

Tapón de aceite para compresor monoblock. (2 uds.)



9,99 €



NE-RP7225

Atornillador recto

- 11.000 r.p.m.
- 2 HP (*)
- 74 Lt/min
- 45 Nm.
- Portapuntas de 3 a 5 mm.



40,95€

NE-RP17113

Taladro recto

- 2.300 r.p.m.
- 2 HP (*)
- 128 Lt/min
- Entrada aire 1/4"



47,25€

10 mm.

NE-RP17102

Taladro

- 1.800 r.p.m.
- 2 HP (*)
- 114 Lt/min
- Entrada aire 1/4"



58,80€

10 mm.

NE-RP17108

Taladro

- 700 r.p.m.
- 2 HP (*)
- 114 Lt/min



70,35€

13 mm.

NE-RP17407

Llave impacto

- 7.500 r.p.m.
- 3 HP (*)
- 183,9 Lt/min
- 610 Nm



81,90€

1/2"

NE-RP7426

Llave impacto

- 8.500 r.p.m.
- 3 HP (*)
- 142 Lt/min
- 610 Nm.



114,66€

1/2" Mini

NE-RP7462

Llave impacto

- 4.600 r.p.m.
- 3 HP (*)
- 183,9 Lt/min
- 1800 Nm



208,95€

3/4"

NE-RP7488

Llave impacto

- 3.600 r.p.m.
- 5 HP (*)
- 295 Lt/min
- 3100 Nm



290,85€

1"

NE-RP17411

Llave de carraca

- 160 r.p.m.
- 2 HP (*)
- 114 Lt/min
- 67,5 Nm



58,80€

1/2"

NE-RP17314

- Miniamoladora
 • 22.000 r.p.m
 • 1,5 HP (*)
 • 126,2 Lt/min



40,95€

NE-RP17610

- Cizalla
 • 1.800 r.p.m
 • 2 HP (*)
 • 114 Lt/min
 • Capacidad de corte max.: 1.6 mm



70,35€

NE-RP8043

- Pistola de grasa
 • 90 PSI - 4 BAR
 • 199 - 170 Lt/min
 • 400 c.c
 • Entrada aire 1/4"



38,85€

NE-RP17621

- Cincelador
 • 79,2 Lt/min
 • 4.500 golpes minuto.



34,65€

NE-RP7336S

- Lijadora orbital
 • 12.000 r.p.m
 • 2 HP (*)
 • 128 Lt/min
 • Plato de goma 150 mm
 • Plato lija 6 "



98,70€

NE-RP7636

- Multifunción
 • 128 Lt/min
 • 6,3 Bar
 • 16.000 osc/min.



69,30€

9

NE-RP7006

- Juego de llaves de vaso 1/2"
 11-12-13-14-16-17-19-21-22. 24 mm.
 Para modelo:
 NE-RP7336S
 NE-RP7426



18,90€

NE-RP7002

- Kit cinceles. Para modelo: NE-RP17621



12,60€

NE-RP7001

- Muelle
 Para modelo:
 NE-RP17621



6,30€

NE-RP7636-1

- Kit multiusos
 Para modelo:
 NE-RP7636



21€

NE-RP7336S-1

- Plato goma 150 mm
 Para modelo:
 NE-RP7336S



6,30€

NE-RP7336S-2

- Pack 10 lijas GR80.
 Para mod.: NE-RP7336S5
NE-RP7336S-3
 Pack 10 lijas GR120.
 Para mod.: NE-RP7336S5
NE-RP7336S-4
 Pack 10 lijas GR180.
 Para mod.: NE-RP7336S5



PACK 5,25€

NE-KN580

Kit neumático:
Llave impacto,
llave carraca,
martillo,
mini esmeril + accesorios

34 pzs

93,45€



NE-KN6BLIS

Kit martillo
cincelador.
6 Bar
4.500 golpes/min
142 l/min



10



35,70€

NE-KN8

Atornillador neumático.
6 Bar
800 r.p.m.

Par de
apriete
regulable



175€

NE-KN10BLIS

Taladro neumático
Cuerpo aluminio fundido.
6 Bar.
Portabrocas automático
reversible: 6 mm.



42€

NE-KN16

Kit pistola de impacto.
6 Bar
310 Nm

16 pzs



57,75€

NE-KN6615K

Remachadora.
6.3 Bar - 7.063 Nm
Carrera pistón 14 mm.
Capacidad remachadora
ø 2,4 - 3,2 - 4,0 - 4,8
Entrada aire 1/4"



114,45€

R16/64K

Clavadora 4 - 7 Bar
Clavo 14 de 32 a 64 mm.



119€

R64KC

Clavadora 8 Bar
Clavo "T" hierro y acero de 18 a 64 mm.



119€

R16/50 KOMBI

Clavadora 5,2-7,6 Bar
Clavo 14 de 20 a 50 mm.
Clavo Mini T de 18 a 50 mm.



119€

R6/35

Clavadora 4 - 7 Bar
Pin y Minibrad 0,6 de 12 a 35 mm.



125€

R8/40

Clavadora 4 - 7 Bar
Pin y Minibrad 0,8 de 12 a 40 mm.



139€

R18/51

Clavadora 4 - 7 Bar. Clavo de 12 de 15 a 50 mm.



79€

R80/16

Grapadora 4 - 7 Bar
Grapa 80 de 6 a 16 mm.



39€

MCCF15PK

Grapadora 4.5-8 Bar
Chapa corrugada de 9 a 15 mm.



309€

R18/30

Clavadora 4-7 Bar
Clavo 12 de 10 a 32 mm.



45€

R12/51D

Clavadora 4 - 7 Bar
Brad 12 de 15 a 50 mm.



42€

SF50/40

Grapadora / Clavadora 4 - 7 Bar
Brad 12 de 12 a 50 mm.
Grapa 90 de 16 a 40 mm.



42€

PIN 0,8 SIN CABEZA

Blister
2.000 uds.

REFERENCIA	LARGO (mm.)	OFERTA BLISTER
MCPINO.8-20BLIS	20	3,81 €
MCPINO.8-30BLIS	30	4,54 €

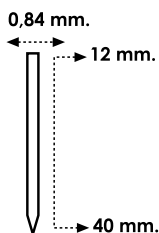

PIN 0,8 CON CABEZA

Blister
2.000 uds.

REFERENCIA	LARGO (mm.)	OFERTA BLISTER
MINIBRAD820BLIS	20	3,81 €
MINIBRAD830BLIS	30	4,54 €

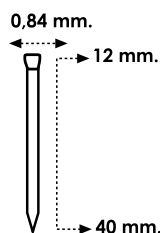

BRAD 12

Blister
1.000 uds.

REF.	LARGO (mm.)	OFERTA BLISTER
MCBRAD12-20BLIS	20	2,54 €
MCBRAD12-30BLIS	30	3,50 €
MCBRAD12-40BLIS	40	4,54 €
MCBRAD12-50BLIS	50	4,54 €

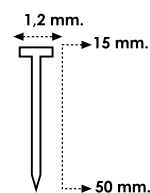

BRAD 14

Blister
1.000 uds.

REFERENCIA	LARGO (mm.)	OFERTA BLISTER
MCBRAD14-30BLIS	30	3,81 €
MCBRAD14-40BLIS	40	4,54 €

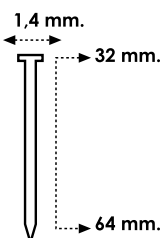

CLAVO MINI T ACERO

Blister
500 uds.

REFERENCIA	LARGO (mm.)	OFERTA BLISTER
MCMINIT-18BLIS	18	8,00 €
MCMINIT-30BLIS	30	8,47 €
MCMINIT-40BLIS	40	9,99 €

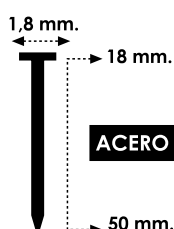

GRAPA 80

Blister
1.000 uds.

REFERENCIA	LARGO (mm.)	OFERTA BLISTER
MCGRAPA80-8BLIS	8	2,54 €
MCGRAPA80-12BLI	12	2,54 €
MCGRAPA80-16BLI	16	3,33 €

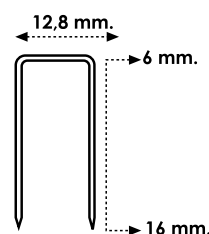

GRAPA 90

Blister
1.000 uds.

REFERENCIA	LARGO (mm.)	OFERTA BLISTER
MCGR90-20BLIS	20	3,99 €
MCGR90-25BLIS	25	3,99 €
MCGR90-30BLIS	30	3,99 €

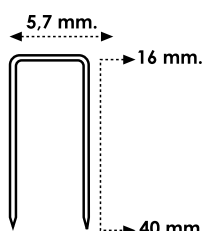

CA-1852

Pistola de pintar.
Cuerpo de aluminio.
Conexión rápida.
Abanico 110 - 220 mm.
Apta para boquillas de Ø 1,5 mm.

Semi-profesional
600 cc.



23 €

CA-1850

Pistola de pintar.
Cuerpo de aluminio.
Conexión rápida.
Abanico 119 - 220 mm.
Apta para boquillas de Ø 1,5 mm.

Semi-profesional
750 cc.



23 €

CA-1851

Pistola de pintar Mini. 3-4 Bar
90-150 Lt/min
Apta para boquillas de Ø 0,5 - 1,8 mm.

125 cc.



29,95 €

CA-1856/3-1.4

Pistola de pintar
3-6 Bar
170-320 Lt/min
Apta para boquillas (1.4, 1.7, 2.0)
Boquilla de serie de Ø 1.4 mm.

600 cc.
Lacas
Barnices



35 €

CA-1856/3

Pistola de pintar
3-6 Bar
170-320 Lt/min
Apta para boquillas (1.4, 1.7, 2.0)
Boquilla de serie de Ø 1.7 mm.

600 cc.
Esmaltes



35 €

CA-1856/3-2.0

Pistola de pintar
3-6 Bar
170-320 Lt/min
Apta para boquillas (1.4, 1.7, 2.0)
Boquilla de serie de Ø 2.0 mm.

600 cc.
Aparejo e
Imprimaciones



35 €

13

CA-1855/3L

Pistola de pintar
3-6 Bar
110-180 Lt/min
Apta para boquillas de Ø 1.4 - 2.0 mm.
Boquilla de serie de Ø 1.7 mm.

1.000 cc.



35 €

CA-1805

Pistola de pintar por gravedad. 1,75 Bar
200 Lt/min.
3 boquillas incluidas

6.000 cc.
Gotelé



35 €

CA-1807L

Pistola de pintar por gravedad 3-6 Bar
275 lt/min.
Boquilla de serie Ø 2,5 mm.

5.000 cc.
lisos



105 €

JUEGO DE BOQUILLAS Y AGUJAS

Para CA-1856/3

Ref.: CA-KIT1.4/1856 (1,4 mm.)
Ref.: CA-KIT2.0/1856 (2,0 mm.)



19€

JUEGO DE BOQUILLAS Y AGUJAS

Para CA-1855/3L

Ref.: CA-KIT1.4/1855 (1,4 mm.)
Ref.: CA-KIT2.0/1855 (2,0 mm.)



19€

JUEGO DE BOQUILLAS Y AGUJAS

Para CA-1805

Ref.: CA-1805-BOQUILL
Juego 3 boquillas



10,50€

JUEGO DE BOQUILLAS Y AGUJAS

Para CA-1806L

Ref.: CA-1806-BOQUILL
Juego 3 boquillas



26€

CA-1150

Pistola de soplar
Presión máx.
10 bar



4,5€

CA-1160

Pistola de soplar
caña larga
Largo 15 cms.
Presión máx. 10 bar



8€

JUEGO DE BOQUILLAS Y AGUJAS

Para CA-1807L

Ref.: CA-KIT1.75-1807L (1.75 mm.)
Ref.: CA-KIT2.5-1807L (2.5 mm.)



59€

CA-1400/1

Pistola de petroleo.
750 cc.
4-7 Bar
Conexión rápida

Ø Boquilla
2.0 mm.



13,50€

CA-1180/1

Hinchador de
neumáticos
0-12 Bar



14€

CA-60G-T/PSI

Hinchador de
neumáticos
0-10 Bar
Latiguillo 1 m.
Ø 63 mm.



57€

CA-1161/2

Pistola de soplar caña larga y boquilla curva
Presión máx.
10 Bar

Conexión rápida
30 cm.



13,50€

CA-1161/3

Pistola de soplar caña larga y boquilla curva
Presión máx.
10 Bar

Conexión rápida
50 cm.



17€

CA-1161/4

Pistola de soplar caña larga y boquilla curva
Presión máx.
10 Bar

Conexión rápida
80 cm.

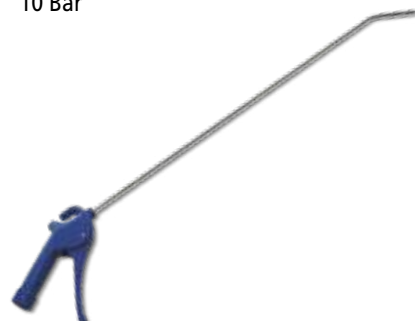

24€

KN-8040

Pistola de arenar-chorrear.
100 Lt/min
Manguera goma:
3 mt. con
ø12x18 mm.
Boquillas:
ø 0,5 mm. (2 uds.)
ø 6,3 mm. (1 ud.)
Presión máx.
9 Bar.

Precisa compresor
de 250 Lt/min



34€

CA-1151

Pistola de soplar
Boquilla curva
Entrada aire 1/4"
Presión máx. 10 bar

Conexión rápida



6€

CA-SPR4-6.5

Tubo espiral
"Poliuretano"
ø 6,5 - 10 mm.

5 mt.



12,09€

15

CA-SPR10-812

Tubo espiral
"Poliuretano"
ø 8 - 12 mm.

10 mt.



24,20€

CA-SRU5-8

Tubo espiral
"Rilsan"
ø 6 - 8 mm.

5 mt.



7,70€

CA-SRU10-8

Tubo espiral
"Rilsan"
ø 6 - 8 mm.

10 mt.



11€

CA-AM80-8

Enrollador automático
manguera. ø Interno 8 mm.
Longitud 10 mt.
Presión máx. 15 bar
Racord salida 1/4

Interior
8 mm.
Aire



103,95 €

CA-AM85-10

Enrollador automático
manguera. ø Interno
10 mm. Longitud 16 mt.
Presión máx. 15 bar
Racord salida 3/8

Interior
10 mm.
Aire



156,45 €

CA-AM86-13

Enrollador automático
manguera. ø Interno
12,5 mm.
Longitud 16 mt.
Presión máx. 15 bar
Racord salida 1/2

Interior
12,5 mm.
Aire/Agua



292,95 €

CA-1815PRO

Enrollador automático
manguera de aire / agua
Metálico.
40 Bar
Conexión 3/8"

Interior
12,5 mm.
15 mt.



125,69 €

CA-1810

Enrollador automático
manguera de aire
Plástico
Conexión 1/4"
ø 6 mm.
10 Bar

10 mt.



56,72 €

CA-4315-GS

Enrollador automático
Longitud manguera 15 mt.
Cable 3G 1,5 H 05 VVF
Incluye enchufe.
Térmico de protección.

Eléctrico



177,45 €

CA-630

Equilibrador de carga
Longitud cable 1,6 mt.
Peso 0,63 Kg.

Carga
0.4-1.0 Kg



30,45 €

CA-631

Equilibrador de carga
Longitud cable 1,6 mt.
Peso 0,67 Kg.

Carga
1.0-2.0 Kg



34,65 €

CA-633

Equilibrador de carga
Longitud cable 2,5 mt.
Peso 2,85 Kg.

Carga
2.0-4.0 Kg



82,95 €

CA-CK220

Kit aerográfico para compresor 6 pzas.
Pistola de soplar hinchador espiral 5 mt.
3 boquillas.



Conexión rápida

22€

CA-CK3300

Kit aerográfico para compresor 5 pzas.
Pistola de soplar, petroleo, soplador, inflador espiral 5 mt.



Conexión rápida

34€

CAKIT8PRO

Kit aerográfico para compresor 8 pzas.
Pistola de pintar, de petroleo, soplador, inflador, espiral 5 mt. 3 boquillas



Conexión rápida

43€

17

CA-MANGUERA10

Manguera de goma 20 Bar

10 mt.



20,95€

CA-MANGUERA20

Manguera de goma 20 Bar

20 mt.



33,02€

CA-MANGUERA50

Manguera de poliuretano 20 Bar

50 mt.



45,15€

REDUCTOR MACHO-HEMBRA

REF.	DESCRIPCIÓN	OFERTA
CA-270/1	De 1/8" a 1/4"	2,71 €
CA-270/3	De 1/4" a 3/8"	2,90 €
CA-270/6	De 3/8" a 1/2"	3,84 €
CA-270/9	De 1/2" a 3/4"	4,22 €



CONEXIÓN HEMBRA

REF.	DESCRIPCIÓN	OFERTA
CA-280/5	De 1/4" a 1/4"	4,24 €
CA-280/8	De 3/8" a 3/8"	3,97 €
CA-280/10	De 1/2" a 1/2"	5,79 €



REDUCTOR MACHO-MACHO

REF.	DESCRIPCIÓN	OFERTA
CA-290/2	De 1/8" a 1/4"	2,84 €
CA-290/5	De 1/4" a 1/4"	2,84 €
CA-290/6	De 1/4" a 3/8"	3,08 €
CA-290/8	De 3/8" a 3/8"	3,08 €
CA-290/9	De 3/8" a 1/2"	3,70 €
CA-290/10	De 1/2" a 1/2"	3,70 €



LLAVE DE PASO

REF.	DESCRIPCIÓN	OFERTA
CA-495/1	1/4" H-H	10,40 €
CA-495/2	3/8" H-H	10,40 €
CA-495/3	1/2" H-H	16,21 €
CA-495/4	3/4" H-H	15,63 €



CA-1110

Boquilla válida para neumáticos ø 6mm.



2,21 €

CA-1110/5

Kit de accesorios universales para inflado



3,86 €

18

CA-495/5P

Llave de paso
De 1/4" P M-M



6,37 €

CA-466/2

Enchufe rápido universal de seguridad para manguera ø 8 mm.



26,63 €

CA-469

Enchufe rápido universal de seguridad.

CA-469/1 - 1/4"
CA-469/2 - 3/8"



26,63 €

Rosca hembra

CA-470

Enchufe rápido universal de seguridad.

CA-470/1 - 1/4"
CA-470/2 - 3/8"
CA-470/3 - 1/2"

Rosca macho



26,63 €

ENCHUFE RÁPIDO UNIVERSAL

Rosca hembra

REF.	DESCRIPCIÓN	OFERTA
CA-459/1	De 1/4"	4,63 €
CA-459/2	De 3/8"	5,29 €



ENCHUFE RÁPIDO UNIVERSAL CON RACOR PARA MANGUERA

REF.	DESCRIPCIÓN	OFERTA
CA-456/1	ø 6 mm.	6,95 €
CA-456/2	ø 8 mm.	4,63 €
CA-456/3	ø 10 mm.	5,68 €



ENCHUFE RÁPIDO UNIVERSAL

Rosca macho

REF.	DESCRIPCIÓN	OFERTA
CA-460/1	De 1/4"	4,63 €
CA-460/2	De 3/8"	5,56 €
CA-460/3	De 1/2"	5,79 €



CONEXIÓN RÁPIDA PARA MANGUERA

REF.	DESCRIPCIÓN	OFERTA
CA-445/3	Ø 6 mm.	2,03 €
CA-445/4	Ø 8 mm.	1,74 €



CONEXIÓN RÁPIDA

Rosca hembra

REF.	DESCRIPCIÓN	OFERTA
CA-449/2	De 1/4"	1,74 €
CA-449/7	De 3/8"	3,01 €



CONEXIÓN RÁPIDA

Rosca macho

REF.	DESCRIPCIÓN	OFERTA
CA-450/2	De 1/4"	1,74 €
CA-450/7	De 3/8"	2,78 €



GRIFO PURGADOR

REF.	DESCRIPCIÓN	OFERTA
CA-490/1	De 1/4"	3,59 €
CA-490/2	De 3/8"	4,06 €

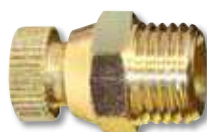

VÁLVULA DE SEGURIDAD

REF.	BAR	DESCRIPCIÓN	OFERTA
CA-565/4	11	De 3/8"	8,10 €
CA-565/1	8,8	De 1/4"	4,63 €



RACOR EN "L"

REF.	DESCRIPCIÓN	OFERTA
CA-260/1	1/8" - 1/8"	3,65 €
CA-260/2	1/4" - 1/4"	3,83 €
CA-260/3	3/8" - 3/8"	3,94 €



CA-485

Racor 3 vías, 2 hembras y 1 macho. 1/4" - 1/4"



4,40 €

NE-KN8055

Mini lubricador 1/4"



5,21 €

CA-49A

Doble tuerca fresada 1/4" - 1/4"



3,47 €

CA-874

Filtro de aire cuello largo. 3/8"



6,37 €

CA-875/5

Filtro plástico profesional para compresores. 3/8 - 1/2"



6,37 €

CA-875/6

Filtro metálico profesional para compresores. 1/4"

Con silenciador



8,69€

CA-875/8

Filtro metálico profesional para compresores. 1/2"



8,69€

CA-PRO25VX-27

Filtro de plástico profesional para compresores. 3/8"



8,69€

CA-740

Rosca inferior. Ø 63 mm. 1/4 ". 12 bar



CA-760

Rosca trasera. Ø 63 mm. 1/4 ". 12 bar

9,92€

CA-780

Rosca trasera. Ø 50 mm. 1/4 ". 12 bar



CA-790

Rosca trasera. Ø 40 mm. 1/8 ". 12 bar

7,72€

CA-970PRO

Regulador de presión con manómetro



14,33€

CA-950/1

Regulador de presión con manómetro y 2 enchufes rápidos. 180 Lt./min. 3/8" 0 - 12 bar. Conexión macho.



31,26€

CA-950/2

Regulador de presión con manómetro y 2 enchufes rápidos. 180 Lt./min. 1/2" 0 - 16 bar. Conexión macho.



41,67€

CA-924

Grupo filtro reductor lubricador 240 Lt./min. 1/4" 0-12 bar 8,4 C.M.F. 14,4 m³/h



62,51€

CA-930/12

Grupo filtro reductor lubricador 450 Lt./min. 3/8" y 1/2" 0-12 bar 15,8 C.M.F. 27 m³/h.



86,10€

CA-922

Regulador de presión con manómetro y filtro 240 Lt./min. 1/4" 0-12 bar 8,4 C.M.F. 14,4 m³/h



27,78€

CA-940/12

Regulador de presión con manómetro y filtro 450 Lt./min. 3/8" y 1/2" 0-12 bar 15,8 C.M.F. 27 m³/h.



53,25€

CA-920

Filtro purificador
Conexión
hembra 1/4"



24,31 €

CA-919/12

Filtro purificador
Conexión
hembra 3/8"
y 1/2"



42,83 €

CA-871/1

Presostato con válvula
de arranque.
8 bar.
Potencia: 2 HP
monofásico.

Conexión
rápida



17,95 €

CA-871/2

Presostato con válvula
de arranque.
8 bar. Monofásico
con rosca para
Huracán, Tornado,
Tifón, Pro6,
Pro 24, Pro 50.



13,23 €

CA-840/1

Presostato sin válvula
de arranque.
10 bar.
Potencia: de
2 HP a 3 HP.
3-6 AMP.



70,62 €

CA-840/2

Presostato sin válvula
de arranque.
10 bar.
Potencia: de
3-5,5 HP.
6-10 AMP.



72,93 €

CA-840/3

Presostato sin válvula
de arranque.
10 bar. Potencia:
de 4HP a 7,5 HP.
10-16 AMP.



72,93 €

CA-921

Lubricador de aceite
42 cc.
Conexión hembra
1/4" - 1/4"
0-12 bar



26,63 €

CA-929/12

Lubricador de aceite
68 cc.
Conexión hembra
3/8" y 1/2"
0-12 bar



41,67 €

VÁLVULA ANTI-RETORNO

REF.	DESCRIPCIÓN	OFERTA
CA-PRO25VX-57	Para compresores VX	9,37 €
CA-PRO24R1063	Para compresores directos (excepto VX)	7,17 €
CA-PRO6SILENT43	Para compresores silenciosos	7,17 €
CA-1127190009	Para compresores de correas (3HP)	17,9 €



CODO PARA COMPRESOR

REF.	DESCRIPCIÓN	OFERTA
CA-PRO24R1043	Para compresores directos	1,93 €
CA-PRO6SILENT47	Para compresores silenciosos	1,65 €
CA-1127080016	Para compresores de correas (3HP)	12,40 €



CE-EVOLUTION18X

230 V. - 50/60 Hz
140 A
ø electrodo:
1,6-3,25 mm.
56 V.
Kw 2,5 (45%)
2,2 Kg.



145 €

CE-EVOLUTION20X

230 V. - 50/60 Hz
160 A
ø electrodo:
1,6-4,0 mm.
56 V.
Kw 3,9 (50%)
2,5 Kg.



165 €

CE-MINI140X

230 V. - 50/60 Hz
140 A
ø electrodo:
1,6-3,25 mm.
62 V.
Kw 4,6
2 Kg.



119 €

CE-TITANCEL210

230 V. - 50/60 Hz
20-200 A
ø electrodo:
1,6-5,0 mm.
90 V.
Kw 2,5 (45%)
2,4 Kg.

Ideal para electrodo
celulósico y aluminio
Pantalla digital



289 €

CE-ULTRA170PLUS

230 V. - 50/60 Hz
170 A
ø electrodo:
1,6-3,25 mm.
56 V.
5 Kg.

DIN 9-13



179 €

22

* Incluye portaelectrodos,
pinza de tierra, máscara
de soldadura y cepillo de
martillo

CE-ULTRA200PLUS

230 V. - 50/60 Hz
200 A
ø electrodo:
1,6-4(5) mm.
56 V.
6,9 Kg.

DIN 9-13



209 €

CE-TITANIUM161

230 V. - 50/60 Hz
160 A
ø electrodo:
1,6-4,0 mm.
58 V.
6,44 Kg.

TOP
LINE



229 €

CE-TITANIUM201

230 V. - 50/60 Hz
200 A
ø electrodo:
1,6-5,0 mm.
58 V.
6,44 Kg.

TOP
LINE



259 €

CE-MAXMIG220

230 V. - 50/60 Hz
20-220 A
Ø Hilo máx.: 1,0 mm.
Bobina max 15 Kg.
(300 mm.)
Conexión D:
Ø 25
22 Kg.

Mig-Mag/MMA
TIG-DC-LIFT
Sinérgico



859€

CE-MAXMIG270

230 V. - 50/60 Hz
20-250 A
Ø Hilo máx.: 1,2 mm.
Bobina max 15 Kg.
(300 mm.)
Conexión D:
Ø 25
23 Kg.

Mig-Mag
MMA
TIG-DC-LIFT



1.049€

CE-PROMIG165

230 V. - 50/60 Hz
20 - 165 A.
Ø electrodo 1,6-3,25 mm.
Ø hilo max 1,0 mm.
Bobina max 5 Kg.
(200 mm.)
Conexión D:
Ø 25
8,7 Kg.

Mig-Mag
MMA
TIG-DC-LIFT



375€

CE-PROMIG200

230 V. - 50/60 Hz
200 A.
Ø electrodo:
1,6-4 mm.
Ø hilo max 1,0 mm.
Bobina max 5 Kg.
(200 mm.)
Conexión D:
Ø 50
12 Kg.

Mig-Mag/MMA
TIG-DC-LIFT
Pantalla LCD
Sinérgico



539€

CE-PROMIG 215

230 V. - 50/60 Hz
220 A.
Ø electrodo:
1,6-4 mm.
Ø hilo max 1,0 mm.
Bobina max 15 Kg.
(300 mm.)
Conexión D:
Ø 50
20 Kg.

Mig-Mag/MMA
TIG-DC-LIFT
Pantalla LCD
Sinérgico



799€

CE-PROMIG220

230 V. - 50/60 Hz
220 A.
Ø electrodo
1,6-3,25 mm.
Ø hilo max 1,2 mm.
Bobina max 15 Kg.
(300 mm.)
Conexión D:
Ø 25
22 Kg.

Mig-Mag/MMA
TIG-DC-LIFT
Sinérgico



999€

TOP
LINE

23

CE-PROMIG250PUL

230 V. - 50/60 Hz
220 A.
Ø electrodo:
1,6-3,25 mm.
Ø hilo max 1,2 mm.
Bobina max 15 Kg.
(300 mm.)
Conexión D:
Ø 50
22 Kg.

Mig-Mag/MMA
TIG-DC-LIFT
Pulsado
Sinérgico



1.999€

CE-PROMIG430SYN

400 V. - 50/60 Hz
300 A.
Ø electrodo:
1,6-6 mm.
Ø hilo max 1,2 mm.
Bobina max 15 Kg.
(300 mm.)
37 Kg.

Mig-Mag/MMA
TIG-DC-LIFT
Sinérgico



1.995€

CE-PROMIG440SYN

400 V. - 50/60 Hz
400 A.
Ø electrodo:
1,6-8 mm.
Ø hilo max 1,6 mm.
Bobina max 15 Kg.
(300 mm.)
42 Kg.

Mig-Mag/MMA
TIG-DC-LIFT
Sinérgico



2.599€

CE-PROMIG430PULSE

400 V. - 50/60 Hz
300 A.
Ø electrodo:
1,6-6 mm.
Ø hilo max 1,2 mm.
Bobina max 15 Kg.
(300 mm.)
39 Kg.

Mig-Mag/MMA
TIG-DC-LIFT
Sinérgico



TOP
LINE

2.625 €

CE-PROMIG430AQU

400 V. - 50/60 Hz
300 A.
Ø electrodo:
1,6-6 mm.
Ø hilo max 1,2 mm.
Bobina max 15 Kg.
(300 mm.)
49 Kg.

Mig-Mag/MMA
TIG-DC-LIFT
Sinérgico



3.675 €

CE-PROMIG323

230 V. - 50/60 Hz
220 A
Ø electrodo:
1,6-4,0 mm.
Ø hilo max 1,2 mm.
Bobina max 15 Kg.
(300 mm.)
Incluye 2
antorchas
52 Kg.

Mig-Mag/MMA
TIG-DC-LIFT
Sinérgico



1.889 €

CE-PROMIG323/SG

230 V. - 50/60 Hz
220 A
Ø electrodo:
1,6-4,0 mm.
Ø hilo max 1,2 mm.
Bobina max 15 Kg.
(300 mm.)
Incluye 2
antorchas
+ spool gun
52 Kg.

Mig-Mag/MMA
TIG-DC-LIFT
Sinérgico



SPOOL GUN M6
TE-802407

2.499 €

CE-PROMIG343WAV

230 V. - 50/60 Hz
220 A
Ø electrodo:
1,6-4,0 mm.
Ø hilo max 1,2 mm.
Bobina max 15 Kg.
(3 uds.) (300 mm.)
Incluye 3 antorchas.
59 Kg.

Mig-Mag/MMA
TIG-DC-LIFT
Pulsado



TOP
LINE

3.399 €

SPOOL GUN M6

Ref. TE-802407
Bobina hilo aluminio 0,8 gr.
Válido para mod. Promig 323.



524,57 €

CE-TROLLEY

Válido para modelos Promig



129 €

CE-TITANTIG200

230 V. 200 A
Ø electrodo 1,6-5,0 mm.
56 V. Alta Frecuencia
7 Kg. Incluye torcha Tig
SR26 - 4mt.

TIG-DC-HF
Down time
Post time



329 €

Opcional:
CE-TORCHATIG8MT 8 mt.
P.V.P.: 139,13€

SP-3445K

230 V. 50 Hz
Potencia permanente 100% 12 Kva
Corriente salida máx. en corto: 1,8 Kva

4 Memorias



MADE IN EUROPE



649 €

SP-TSW1000CAR

230 V. 50/60 Hz
Potencia Nominal 1.000 Kva
Capacidad 66 mf
4 Programas de soldadura
Pernos 2-6 ø mm.

Válida para aluminio



MADE IN EUROPE



1.599 €

SP-3450

400 V. 50/60 Hz
Potencia máx. 50 Kva
Potencia nominal 50%: 10 Kva
Corriente máx. 8000 A
Protección alimentación: (retardo) 25A
IP21
105 Kg.



MADE IN EUROPE



3.799 €

CE-ALUPRO200

230 V. 50/60 Hz
Corriente salida 200 A
Tensión en vacío 80 V.

Aluminio



1.399 €

TE-804150 - KIT DE CONSUMIBLES DELUXE BOX

Contiene: 50 arandelas planas AIMg - 50 arandelas planas AISi - 50 arandelas rosca AIMg
50 arandelas rosca AISi - 50 pins AISi - 1 extractor - 1 sostenedor

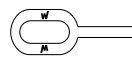

AIMg (50 pcs)
804140

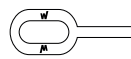

AISi (50 pcs)
804142

Sostenedor
(1 ud.)
804147

Extractor
(1 ud.)
742778

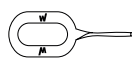

AIMg (50 pcs)
804141

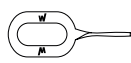

AISi (50 pcs)
804143

Pin ALSi (50 pcs) 804145

282 €

25

OPCIONALES

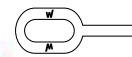

Ai 99,5% (50 pcs) 804250

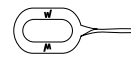

Ai 99,5% (50 pcs) 804251

CONSUMIBLES

ARANDELAS PLANO (50 UDS.)	OFERTA	ARANDELAS ROSCA (50 UDS.)	OFERTA		OFERTA
TE-804250	32,00 €	TE-804251	33,14 €	Pin ALSi (50 pcs)	TE-804145 72,00 €
TE-804140	32,00 €	TE-804141	33,14 €	Sostenedor (1 ud.)	TE-804147 27,14 €
TE-804142	45,71 €	TE-804143	50,51 €	Extractor (1 ud.)	TE-742778 31,00 €

CE-SPOT5500DUO

230 V. 50/60 Hz
Corriente máx. 3.800 A
Tensión en vacío 5,8 V.
Potencia máx. 10,5 Kw.

2 pistolas
Manual y automático
Acero



CONSULTAR PRECIO

CE-SPOT5500AUTO

230 V. - 10,5 Kw.
Fusible de red 16A
5.5V. - 3800A

Monofásico
Pistola automática
(sin gatillo)



673 €

SC-PLC40

Corte plasma
230 V.
15-40 A
Cobre: hasta 4 mm.
Acero: hasta 8 mm.
Aluminio:
hasta 6 mm.
Hierro:
hasta 10 mm.

Corte máx.
10 mm.



259 €

CE-CUT31K

Corte plasma
230 V.
10-40 A
Cobre: hasta 5 mm.
Aluminio: hasta 9 mm.
Acero : hasta 12 mm.

Corte máx.
12 mm.
con compresor



1.049 €

CE-CUT41

Corte plasma
230 V.
10-60 A
Cobre: hasta 8 mm.
Aluminio:
hasta 15 mm.
Acero:
hasta 20 mm.

Corte máx.
20 mm.



1.049 €

SC-790600706

KIT para PLC40

25 €



TE-804188

KIT para CUT31K

85,71 €



TE-804189

KIT para CUT41

85,71 €



CE-GASCO2PLUS

Bombona. 1 Lt.
No recargable.
CO₂.
Tara: 1.190 grs.
Test de presión: 145 Bar

Para hilo
de acero



23,37 €

CE-GASARGONPLUS

Bombona. 1 Lt.
No recargable.
Argón.
Tara: 1.190 grs.
Presión a +20°: 110 Bar
Test de presión: 145 Bar

Para hilo
de aluminio
TIG



23,37 €

CE-GASMIXTOPLUS

Bombona. 1 Lt.
No recargable.
CO₂ (20%) + Argón.(80%)
Presión a +20°: 110 Bar
Test de presión: 145 Bar

Para hilo de acero
e inoxidable



23,37 €

TE-722119

Mano reductor para regular la
presión de salida del gas.



59,96 €

CP-KITENLACE

Kit enlace para bombona (no
recargable). Para conectar el
inverter a la bombona de gas.



46,75 €

SP-24/1600

Arrancador portátil
Batería 12 V.
Amp. Arranque
1.600 A-P. L.E.



225€

SP-P5/2500

Arrancador portátil
Batería 12 V.
Amp. Arranque
2.500 A-P. L.E.



299€

SP-P01-TR-1224

Arrancador portátil
Batería 12-24 V.
Amp. Arranque
5.000-2.600 A-P. L.E.



899€

SP-P5/12-24V

Arrancador portátil
Batería 12-24 V.
Amp. Arranque
5.000-2.500 A-P. L.E.



659€

SP-H5HYBRID

Arrancador portátil
Batería 12 V.
Amp. Arranque
3.500 A-P. L.E.



399€

CE-FENIX20

Cargador alimentador
Batería 12-24 V.
9 Amp. 4,5A
115 Ah



55€

SP-LEM61211

Cargador/alimentador
1,1 Amp.
Modo carga 2,2 Ah min.- 32 Ah máx.
Mantenimiento hasta 100 Ah

6 - 12 V.
Gel



45€

SP-LEM122470

Cargador/alimentador
7-3,5 Amp.
Modo carga: 12 V. 14 Ah min.- 50 Ah máx.
Modo carga: 24 V. 14 Ah min.- 75 Ah máx.
Mantenimiento hasta 225 Ah

12 - 24 V.
Gel



79€

SP-LEM1224250

Cargador/alimentador
25-12,5 Amp.
Modo carga: 12 V. 50 Ah min.- 450 Ah máx.
Modo carga: 24 V. 25 Ah min.- 230 Ah máx.
Mantenimiento hasta 500 Ah

12 - 24 V.
Gel



349€

SP-GX2

Cargador 12 V.
2.0 Ah
Carga máx.: 1,2 - 60 Ah.

Automático
Litio



55€

SP-GX5

Cargador 12 V.
5.0 Ah
Carga máx.: 1,2 - 110 Ah.

Automático
Litio



69€

SP-GX15

Cargador 12-24 V.
15 Ah
Carga máx.: 24 - 300 Ah.

Automático
Litio



189€

SP-MARS2415

Batería 12-24 V.
15 Amp.
200 Ah 100%
Cargador/alimentador



219€

SP-MARS2430

Batería 12-24 V.
30 Amp.
400 Ah 100%
Cargador/alimentador



299€

DEFENDER 12

230 V. - 62 W.
6 - 12 V.
2A/40 A
TE-807607

DEFENDER 20 BOOST

230 V. - 110 W.
12 - 24 V.
5A/180 A
TE-807600

ALASKA 150 START

Batería 12 V.
20 Amp.
10/200 Ah 100%
Cargador
TE-807576

Led

Tronic

28



44€

99,43€

110€

ALASKA 200 START

Batería 12-24 V.
25/12 Amp.
25/300 Ah 100%
Cargador
TE-807577

Led

Tronic

T-CHARGE12EVO

230 V. - 55 W.
6-12 V.
4 (12 V.) / 1 (6 V.)
4 (12 V.) / 1 (6 V.)
2/70 Ah
TE-807578

Pulse
Tronic

T-CHARGE20EVO

230 V. - 115 W.
12-24 V.
8 (12 V.) / 4 (6 V.)
8 (12 V.) / 4 (6 V.)
5/180 Ah
TE-807596

Pulse
Tronic



145€

83€

160€

MÁXIMA 160

230 V. 50/60 Hz
20-150 A
Ø Hilo acero: 0,6-0,9 mm.
Ø Hilo sin gas/ alu:
0,8-1,0 mm.
Bobina max 5Kg.
TE-816085

M Mig-Mag



539€

MÁXIMA 190

230 V. 50/60 Hz
20-170 A
Ø Hilo acero 0,6-0,8 mm.
Ø Hilo sin gas 0,8-1,2 mm.
Ø Hilo alu 0,8 -1 mm.
Bobina max 5Kg.
TE-816086

Mig-Mag



599€

TECHNOMIG 225

230 V. 50/60 Hz
35-220 A
Ø Hilo acero 0,6-1,0 mm.
Ø Hilo alu 0,8-1,0 mm.
Ø Hilo sin gas 0,8-1,2 mm.
Ø Hilo inox 0,8-1,0 mm.
TE-816057

Mig-Mag



1.160€

TECHNOMIG 260

230 V. 50/60 Hz
20-250 A
Ø Hilo acero 0,6-1,0 mm.
Ø Hilo alu 0,8-1,0 mm.
Ø Hilo sin gas 0,8-1,2 mm.
Ø Hilo inox 0,8-1,0 mm.
TE-816056



1.242,86€

MASTERMIG 300

400 V. 50/60 Hz
40-300 A
Ø Hilo acero 0,6-1,2 mm.
Ø Hilo inox 0,6-1,2 mm.
Ø Hilo alu 0,8-1,0 mm.
TE-827003

Mig-Mag
Devanador
extraible



2.359€

MASTERMIG 400

400 V. 50/60 Hz
40-400 A
Ø Hilo acero 0,6-1,6 mm.
Ø Hilo inox 0,6-1,6 mm.
Ø Hilo alu 0,8-1,2 mm.
TE-827004

Mig-Mag
Devanador
extraible



2.785€

MASTERMIG 500

400 V. 50/60 Hz
40-300 A
Ø Hilo acero 0,6-2,0 mm.
Ø Hilo inox 0,8-2,0 mm.
Ø Hilo alu/bz 0,8-1,2 mm.
TE-827007

Mig-Mag
Devanador
extraible



3.428€

MASTERMIG 500 Aqua

400 V. 50/60 Hz
40-300 A
Ø Hilo acero 0,6-2,0 mm.
Ø Hilo inox 0,8-2,0 mm.
Ø Hilo alu/bz 0,8-1,2 mm.
TE-822008

Mig-Mag
Devanador
extraible



4.399€

ELECTROMIG 450

400 V. 50/60 Hz
20-400 A
Ø Hilo acero
0,6-2,0 mm.
Ø Hilo inox
0,8-2,0 mm.
Ø Hilo alu
0,8-1,6 mm.
Ø Hilo bz
0,8-1,6 mm.
TE-816190

Mig-Mag/MMA
TIG-DC-LIFT
Sinérgico



**CONSULTAR
PRECIO**

ELECTROMIG 550 Aqua

400 V. 50/60 Hz
20-500 A
Ø Hilo acero
0,6-2,4 mm.
Ø Hilo inox
0,8-2,4 mm.
Ø Hilo alu
0,8-1,6 mm.
Ø Hilo bz
0,8-1,2 mm.
TE-816194



Mig-Mag/MMA
TIG-DC-LIFT
Sinérgico



**CONSULTAR
PRECIO**

INFINITY PLASMA 40

10-40 A - 230V. 50/60 Hz
Corte máx. 15 mm. 100 Lt/min
Bar 4-5 - 29 amp - máx
40 amp - 20%
TE-816145

12 mm.



621,43 €

SUPERIOR PLASMA 70

400V. - 13 amp-máx - 70-30A
16 amp-máx - 50-35 A
Corte máx. 30 mm.
200 Lt/min - Bar 4-5
TE-816170



2.279 €

SUPERIOR PLASMA 100

400V. - 23,7 amp - 100-30A
20,8 amp - 70-30 A
Corte máx. 40 mm.
290 Lt/min - Bar 4-5
TE-816172



3.521 €

SUPERIOR PLASMA 160

400V. 100-30 A - 38 amp
40 amp - 150-30A
Corte máx. 50 mm.
290 Lt/min - Bar 4-5
TE-816174



**CONSULTAR
PRECIO**

TECHNOLOGY TIG 182

230 V. - 4,3 KW.
5 -160 A
Corriente al 50%
85 A.
Ø electrodo: 1,6 - 3,2 mm.
TE-852030

Tig-AC-DC
MMA



1.930 €

TECHNOLOGY TIG 222

230 V. - 5,5 KW.
5 -200 A
Corriente al 50%
100 A.
Ø electrodo: 1,6 - 4,0 mm.
TE-852054

Tig-AC-DC
MMA



2.112 €

CLEANTECH 200

Limpiador soldadura 230 V.
2 Posiciones
de regulación
TE-850020



673 €

DIGITAL PULLER 5500

400 V. - 10,5 Kw.
Fusible de red 10 A.
5,5 V. - 3.800 A
TE-828128

Trifásico
Pistola
automática
(sin gatillo)



649 €

DIGITAL PULLER 5500

230 V. - 10,5 Kw.
Fusible de red 16 A.
5,5 V. - 3.800 A
TE-828127

Monofásico
Pistola
automática
(sin gatillo)



673 €

DIGITAL PULLER 5500 DUO

230 V. - 5,6 V.
10,5 Kw.
3.800 A
TE-828131



**CONSULTAR
PRECIO**

MODULAR 20/TI

230 V. - 6 Kw.
Fusible de red
16 A. - 2 V.
3.800 A
TE-823015

1+1 mm.



622 €

DIGITAL MODULAR 230

230 V. - 13 Kw.
Fusible de red
25 A. - 2,5 V.
6.300 A
TE-823016

2+2 mm.



767 €

DIGITAL MODULAR 400

400 V. - 13 Kw.
Fusible de red
16 A. - 2,5 V.
6.300 A
TE-823017

2+2 mm.



788 €

SPRINTER 3000 START

230 V.
12-24 V.
45 A.
300 A.
20/700 Ah.
TE-829390



299 €

SPRINTER 4000 START

230 V.
12-24 V.
75 A.
400 A.
20 /1.000 Ah
TE-829391



375 €

SPRINTER 6000 START

230 V.
12-24 V.
90 A.
570 A.
20 /1.550 Ah
TE-829392



477 €

STUDDER BOX TE-143780



77,14 €

KIT CONSUMIBLES DENT PULLING TE-802838



58,28 €

STUDDER READY BOX TE-143722



44,23 €

32

ESTRELLAS	CODIGO	OFERTA
ESTRELLAS FE-CU	TE-802296 100 uds.	61 €
MANDRIL	TE-722954	8,85 €

RECALCADO	CODIGO	OFERTA
ELECTRODO	TE-722963	8 €

REMIENDO	CODIGO	OFERTA
ELECTRODO	TE-722964	33,94 €

SOLDADURA 1 LADO	CODIGO	OFERTA
ELECTRODO	TE-742485	19,29 €

REMACHES M5 - Ø5	CODIGO	OFERTA
18 mm.	TE-802301 100 uds.	12,34 €
10 mm.	TE-802299 100 uds.	10,29 €
12 mm.	TE-802302 100 uds.	12,34 €
25 mm.	TE-802304 100 uds.	13,41 €
ELECTRODO M5 - M6	TE-722959	13,37 €

REMACHES (M4)	CODIGO	OFERTA
15 mm	TE-802300 100 uds.	9,67 €
ELECTRODO	TE-722958	22,50 €

REMACHES (Ø3)	CODIGO	OFERTA
3,2 mm	TE-802297 100 uds.	7,60 €
4,5 mm	TE-802298 100 uds.	6,70 €
ELECTRODO	TE-742484	14,40 €

HILO ONDULADO	CODIGO	OFERTA
300 mm	TE-802339 100 uds.	25,57 €
200 mm	TE-802728 50 uds.	20,57 €
POSICIONADOR	TE-742087	37,03 €

CALENTAMIENTO	CODIGO	OFERTA
150 mm CARBON	TE-802608 5 uds.	7 €

ARANDELAS	CODIGO	OFERTA
Ø 8 mm	TE-802295 100 uds.	7 €
MANDRIL	TE-722955	16,02 €

ARANDELAS CON GANCHO	CODIGO	OFERTA
ARANDELAS RECTAS	TE-802943 50 uds.	17 €
ARANDELAS DOBLADAS	TE-802944 50 uds.	20 €
ELECTRODO	TE-742541	24,69 €
210mm PALANCA	TE-484244	4 €
410mm PALANCA	TE-484635	4,11 €

CLAVOS	CODIGO	OFERTA
Ø 2x50 mm	TE-802293 100 uds.	6,60 €
Ø 2,6x50 mm	TE-802294 100 uds.	8,90 €
ELECTRODO	TE-742486	14,40 €
MANDRIL	TE-722953	86,40 €

MASA PARA PUNTEADO	CODIGO	OFERTA
	TE-802462	12,34 €

EXTRACTORES	CODIGO	OFERTA
	TE-722952	39,77 €
	TE-802451	66,06 €

MT15

Antorcha para soldadura con hilo. Disponible en 2, 3 y 4 mt.



REF.	DESCRIPCIÓN	OFERTA
CE-AX15/2MALU	ALUMINIO	99,06 €
CE-AX15/3M	ACERO, INOX, FLUX	76,80 €
CE-AX15/4M	ACERO, INOX, FLUX	83,48 €

MT25

Antorcha para soldadura con hilo. Disponible en 2, 3, 4 y 5 mt.



REF.	DESCRIPCIÓN	OFERTA
CE-AX25/2MALU	ALUMINIO	110,19 €
CE-AX25/3M	ACERO, INOX, FLUX	89,04 €
CE-AX25/4M	ACERO, INOX, FLUX	94,61 €
CE-AX25/5M	ACERO, INOX, FLUX	105,74 €

MT36

Antorcha para soldadura con hilo. Disponible en 3, 4 y 5 mt.



REF.	DESCRIPCIÓN	OFERTA
CE-AX36/3M	ACERO, INOX, FLUX	133,56 €
CE-AX36/4M	ACERO, INOX, FLUX	189,21 €
CE-AX36/5M	ACERO, INOX, FLUX	194,78 €

ACCESORIOS ANTORCHAS DE HILO MT

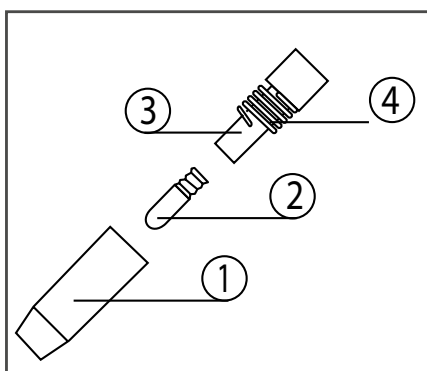

1 - TOBERA

2 - PUNTAS DE CONTACTO



3 - DIFUSOR

4 - MUELLE



KIT CP-KITMT15 Contenido:

Nº	REFERENCIA	DESCRIPCIÓN
1	CP-KITTOBERA	2 Toberas
2	CP-PUNTA0,8	5 Puntas de acero de 0,8 mm.
2	CP-PUNTA1,0	5 Puntas de acero de 1,0 mm.
2	CP-PUNTA1,0ALU	5 Puntas de aluminio y animado 0,9 y 1,0 mm.
3	CP-DIFUSOR15	2 Difusores
4	CP-MUELLE15	2 Muelles

16,70 €

REPUESTOS PARA KIT CP-KITMT15

REFERENCIA	UDS.	OFERTA
CP-KITTOBERA	5	8,90 €
CP-PUNTA0,8	5	6,68 €
CP-PUNTA1,0	5	5,57 €
CP-PUNTA1,0ALU	5	8,90 €
CP-DIFUSOR15	2	6,68 €
CP-MUELLE15	2	2,23 €

KIT CP-KITMT25 Contenido:

Nº	REFERENCIA	DESCRIPCIÓN
1	CP-KITTOBERA25	2 Toberas
2	CP-PUNTA0,825	5 Puntas de acero de 0,8 mm.
2	CP-PUNTA1,025	5 Puntas de acero de 1,0 mm.
2	CP-PUNTA1,0AI25	5 Puntas de aluminio y animado (0,9) de 1,0 mm.
3	CP-DIFUSOR25	2 Difusores
4	CP-MUELLE25	2 Muelles

21,15 €

REPUESTOS PARA KIT CP-KITMT25

REFERENCIA	UDS.	OFERTA
CP-KITTOBERA25	2	10,02 €
CP-PUNTA0,825	5	8,90 €
CP-PUNTA1,025	5	7,79 €
CP-PUNTA1,0AI25	5	8,35 €
CP-DIFUSOR25	2	10,02 €
CP-MUELLE25	2	5,12 €

ROLDANA

Rodillo de arrastre para equipo de hilo.

REFERENCIA	PARA	MEDIDAS	PARA MODELO	OFERTA
CE-PROMIG200-AL	HIERRO / ALUMINIO / FLUX	0,8 - 1,0 mm.	PROMIG 165/200	20,03 €
CE-ROLDA-PROMIG	HIERRO / ALUMINIO / FLUX	0,6 - 0,8 mm.	PROMIG 165/200	17,81 €
TE-742090	ALUMINIO	0,8 - 1,0 mm.	PROMIG 220	21,80 €
TE-722112	ACERO	0,6 - 0,8 mm.	PROMIG 220	20,03 €
TE-742054	ACERO	1,0 - 1,2 mm.	PROMIG 220	16,70 €
TE-722130	FLUX	1,0 - 1,2 mm.	PROMIG 220	32,28 €
TE-722019	ALU-FE	0,6 - 0,8 mm.	MAXMIG 220	10,02 €
TE-722629	ALU-FE	1,0 mm.	MAXMIG 220	7,79 €
TE-722529	FLUX	0,6 - 0,9 mm.	MAXMIG 220	14,47 €

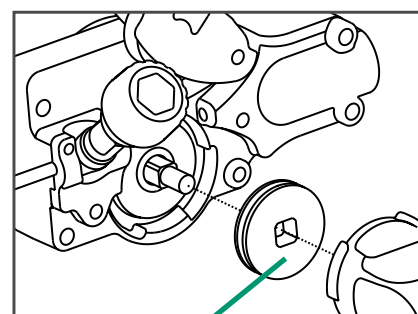

ROLDANA

CE-PANTALLA410

Ligera
 Área de visión:
 105x50 mm.
 Din 12



6,83€

CP-PANTALLA2

Pantalla tipo casco
 Área de visión:
 110x90mm.
 Clase Optica 1
 Din 11



11€

CE-PE400S

Automática. Regulable 9-13
 Área de visión:
 92x35 mm.
 Clase Optica
 1/1/1/2



34€

CE-PE800PRO

Automática. Regulable 9-13
 Área de visión:
 92x42 mm.
 Clase Optica
 1/1/1/2



49€

CE-STARWHITE

Automática.
 Regulable 9-13
 Área de visión:
 98x43 mm.
 Clase Optica
 1/1/1/2

Batería
 recambiable



69€

CE-PE903XL

Automática. Regulable
 5-9 / 9-13
 Área de visión:
 100x67 mm.
 Clase Optica
 1/1/1/1

Batería
 recambiable
 Visión 180°



75€

CE-PE904XL

Automática
 Regulable
 5-9 / 9-13
 Área de visión:
 100x67 mm.
 Clase Optica
 1/1/1/1

Batería
 recambiable
 Visión 180°



75€

CE-PE1000/3XL

Automática.
 Regulable
 4-8 / 8-12
 Área de visión:
 115x85 mm.
 Clase Optica
 1/1/1/1 - 1/1/1/2

Batería
 recambiable
 Visión 180°



215€

BOBINAS DE HILO (MIG)

REFERENCIA	HILO	Ø	CAPACIDAD BOBINA (Kgs)	OFERTA
CP-HILOANIMO,9N	Animado	0,9 mm.	0,8	17 €
CP-HILOACE0,8	Acero	0,8 mm.	0,8	11,07 €
CP-HILOINOX0,8	Inoxidable	0,8 mm.	0,8	25 €
CP-HILOANIM3KG	Animado	0,8 mm.	3	72,35 €
CP-HILOALU0,8	Aluminio	0,8 mm.	0,5	25 €
CP-HILOACE5KG	Acero	0,8 mm.	5	38,96 €



ELECTRODOS RUTILO (CAJA)

REFERENCIA	CARACT.	MEDIDAS	OFERTA
CP-RU2,0CAJA50	50 uds.	2,0 mm.	4,45 €
CP-RU2,5CAJA50	50 uds.	2,5 mm.	4,45 €
CP-RU3,25CAJA50	50 uds.	3,25 mm.	7,79 €
CP-RU2,0CAJA200	200 uds.	2,0 mm.	12,24 €
CP-RU2,5CAJA225	225 uds.	2,5 mm.	15,58 €
CP-RU3,25CAJ140	140 uds.	3,25 mm.	16,70 €
CP-RU4,0CAJ100	100 uds.	4,0 mm.	16,70 €



ELECTRODOS RUTILO (BLISTER)

REFERENCIA	CARACT.	OFERTA
CP-RU1,6BLIS	30 uds. 1,6 mm.	5,57 €
CP-RU2,0BLIS	20 uds. 2 mm.	3,34 €
CP-RU2,5BLIS	20 uds. 2,5 mm	3,34 €
CP-RU3,25BLIS	20 uds. 3,25 mm.	3,34 €

ELECTRODO BÁSICO (BLISTER)

REFERENCIA	CARACT.	OFERTA
CP-BA2,5BLIS	20 uds. 2,5 mm.	4,45 €



ELECTRODOS PARA INOXIDABLE/ALUMINIO (BLISTER)

REFERENCIA	CARACT.	OFERTA
CP-INOX2,0	10 ELEC. INOX 2.0 mm.	12,24 €
CP-INOX2,5	10 ELEC. INOX 2.5 mm.	12,24 €
CP-INOX3,25	10 ELEC. INOX 3.25 mm.	14,47 €
CP-ALU2,5	10 ELEC. ALU. 2.5 mm.	13,36 €
CP-ALU3,25	10 ELEC. ALU. 3.25 mm.	17,81 €



ELECTRODOS TIG

REFERENCIA	CARACT.	OFERTA
Electrodo GRIS. Tungsteno/Cerio al 2%.		
CE-TIGINOX1,6T	Pack 2 uds. 1,6 mm	10,02 €
TE-802220	Caja 10 uds. 1,0 mm.	15,53 €
TE-802222	Caja 10 uds. 1,6 mm	30,53 €
TE-802232	Caja 10 uds. 2,4 mm	63,44 €
TE-802233	Caja 10 uds. 3,2 mm	110,19 €
Electrodo VERDE. Tungsteno Puro. CA. WP		
TE-802234	Caja 10 uds. 1,0 mm	17,45 €
TE-802235	Caja 10 uds. 1,6 mm	29,44 €
TE-802236	Caja 10 uds. 2,4 mm	65,42 €
TE-802237	Caja 10 uds. 3,2 mm	110,19 €

35

PINZAS MASA

REFERENCIA	CARACT.	OFERTA
CP-PINZAM150A	150A.	3,34 €
CP-PINZAM300A	300A.	5,57 €
CP-PINZAM400A	400A.	6,68 €
CP-PINZAM600A	600A.	10,02 €



PINZAS PORTAELECTRODOS

REFERENCIA	CARACT.	OFERTA
CP-PINZA150A	150A.	7,79 €
CP-PINZA300A	300A.	13,36 €
CP-PINZA400A	400A.	14,47 €
CP-PINZA600A	600A.	15,58 €



ESCUADRA MAGNÉTICA

REFERENCIA	OFERTA
CP-ESCUADRA	7,79 €

Soporta hasta 22 kg.



ANTORCHAS TIG

REFERENCIA	Ø mm.	OFERTA
CE-TORCHA	25	87,93 €
CE-TORCHA50	50	99,06 €
CE-TORCHAWP26(4MT)	50	76,80 €
CE-TORCHATIG8MT	50	139,13 €



PIQUETAS

Especial para soldador.

REFERENCIA	CARACT.	OFERTA
CP-PIQUETA	Mango madera	6,57 €
CP-PIQUETAH	Mango hierro	8,35 €



CE-SPRAY

Spray antiadherente para eliminación de proyecciones de soldadura y escorias. Sin Silicona.

7,79 €



CONECTORES

REFERENCIA	CARACT.	OFERTA
CP-CONEC25M	25 mm. (2 uds.) Macho	6,68 €
CP-CONEC50M	50 mm. (1 ud.) Macho	11,13 €
CP-CONEC25H	25 mm. (2 uds.) Hembra	6,00 €
CP-CONEC50H	50 mm. (2 uds.) Hembra	9,90 €



Adaptador de Ø25 a Ø50 mm.
AW-M00581SP P.V.P.: 19,95 €

CABLES DE COBRE

Especial para soldadura.

REFERENCIA	CARACT.	OFERTA
CP-CABLEPRO16	10 m. 16 mm ² .	40,07 €
CP-CABLEPRO25	10 m. 25 mm ² .	54,54 €



CP-085R

Guantes serraje vacuno natural con manguito de 15 cm. Longitud total: 34,5 cm. Talla 10.

Espesor de piel 1,1 mm



5,01 €

CP-123/1

Delantal de serraje vacuno natural de una pieza. (90x60 cm.)

Espesor de piel 1,1 mm



17,81 €

TE-802632

Guantes serraje profesional para soldadura TIG. Serraje anti-calórico e hidrófugo. Forro no inflamable. Largo: 45 cm. Talla 10.

Espesor de piel 1,3 mm



34,88 €

CE-104K

Kit de soldadura con:

- Pantalla de soldar con cristal incluido 50X105 mm.
- Par de guantes de vacuno de 1,1 mm. de espesor de piel.
- Escuadra magnética 4" soporta hasta 22 Kg.
- Escuadra magnética 3" soporta hasta 15 Kg.



25,60 €

KITS Y PANTALLAS PARA SOLDADURA

Kit pantalla protectora separadora. Soporte de metal. Con ruedas. Protegen de UV, arcos ligeros y chispas. Peso: 7,8 Kg.

REF.	CARACTERISTICAS	OFERTA
TE-802676	Pantalla individual roja	63,24 €
TE-802677	Pantalla individual verde	63,24 €
TE-803508	Kit pantalla de protección + soporte 1850x670x1950mm.	163,54 €
TE-803509	Kit pantalla de protección + soporte 1850x670x1950mm.	163,54 €



TE-803508



TE-803509

MPX16E

125 Bar
120 lt/h.
1600 W.
230V./50 Hz.
HI-14749



125 €

MPX19EH

140 Bar
460 lt/h.
1900 W.
230V./50 Hz.
HI-14651



199 €

MPX25EHDS

170 Bar
500 lt/h.
2500 W.
230V./50 Hz.
HI-14752



2 velocidades

232 €

MPX22EHX

160 Bar
450 lt/h.
2200 W.
230V./50 Hz.
HI-14654



Inducción

310 €

MPX25DTS

150 Bar
810 lt/h.
2500 W.
230V./50 Hz.
HI-15052



Sistema DTS
patentado
2 Bombas

319 €

MPX27DTS

160 Bar
850 lt/h.
2700 W.
230V./50 Hz.
HI-15053



Sistema DTS
patentado
2 Bombas

339 €

MPX30EHB

180 Bar
600 lt/h.
2800 W.
230V./50 Hz.
HI-MPX30EHB



Inducción
Bomba
latón

559 €

MPX160CK

160 Bar
510 lt/h.
2900 W.
230 V.
HI-14524



Enrollador no
incluido opcional
Bomba latón

649 €

ACC. ROTATIVA
Ref.: 40151
P.V.P.: 59 €

HI-MPX150HDC

150 Bar - 630 lt/h.
3000 W.
230V./50 Hz.
1.450 r.p.m.



Enrollador no
incluido opcional
Bomba latón

1.099 €

ACC. ROTATIVA
Ref.: 41503
P.V.P.: 160 €

HI-MPX170HDC

170 Bar
780 lt/h.
5000 W.
400V. /50 Hz.



Enrollador
no incluido

Trifásica
Bomba latón

1.320€

ACC. ROTATIVA
Ref.: 41503
P.V.P.: 160 €

HI-MPX200HDK

200 Bar
900 lt/h.
7400 W.
400V. /50 Hz.



Enrollador
no incluido

Trifásica
Bomba latón

1.475€

ACC. ROTATIVA
Ref.: 41503
P.V.P.: 160 €

MPX210TL

207 Bar
570 lt/h.
5 HP
HI-26837

Motor Loncin
Gasolina



549€

ACC. ROTATIVA
Ref.: 46235
P.V.P.: 59 €

MPX210THD

210 Bar
690 lt/h.
5,5 HP
HI-27148

Motor Honda
Gasolina
Bomba latón



869€

ACC. ROTATIVA
Ref.: 46149
P.V.P.: 59 €

AR-1490

280 Bar
960 lt/h.
13 HP
HI-26408

Motor Honda
Gasolina
Bomba latón



2.585€

ACC. ROTATIVA
Ref.: 40964
P.V.P.: 89 €

HI-MPX150HL

150 Bar
500 lt/h.
2500 W.
230V. /50 Hz.

Agua caliente
Bomba latón



1.521€

HI-MPX200HD

200 Bar
900 lt/h.
7400 W.
400V. /50 Hz.

Agua caliente
Trifásica
Bomba latón



3.750€

ARTÍCULO	REF.	MODELO DE MÁQUINA														OFERTA
		MPX 14E	MPX 16E	MPX 17EH	MPX 19EH	MPX 22EH	MPX 25EH	MPX 17EHDS	MPX 19EHDS	MPX 22EHDS	MPX 25EHDS	MPX 20EHX	MPX 22EHX	DTS25	DTS27	
PISTOLA	HI-46160	S	S													25,00 €
PISTOLA	HI-46161			S	S	S	S	S	S	S	S	S	S	S	S	29,00 €
EXTENSIÓN LANZA	HI-46163	S	S													19,00 €
EXTENSIÓN LANZA	HI-46162			S	S	S	S	S	S	S	S	S	S	S	S	19,00 €
BOQUILLA REGULABLE	HI-46165	S														19,00 €
BOQUILLA REGULABLE	HI-46166		S									S				19,00 €
BOQUILLA REGULABLE	HI-46167			S	S			S	S				S			19,00 €
BOQUILLA REGULABLE	HI-46168					S				S						19,00 €
BOQUILLA REGULABLE	HI-46169						S				S					19,00 €
BOQUILLA REGULABLE (2 UDS.)	HI-46656												S	S		23,00 €
BOQUILA TURBO	HI-46164	S	S	S	S	S	S	S	S	S	S	S	S			19,00 €
BOQUILLA TURBO	HI-46655												S	S		25,00 €
PORTABOQUILLA DOBLE	HI-46654												S	S		25,00 €
MANGUERA	HI-46172	S														29,00 €
MANGUERA	HI-46173		S													32,00 €
MANGUERA	HI-46174			S	S	S		S	S	S						35,00 €
MANGUERA	HI-46175						S				S	S	S			39,00 €
MANGUERA	HI-46657												S	S		39,00 €
PROLONGACIÓN 8MT	HI-46189	0	0	0	0	0	0	0	0	0	0	0	0			49,00 €
PROLONGACIÓN 8MT	HI-46658												0	0		49,00 €
KIT DE DETERGENTE	HI-46176	S	S	S	S	S	S	S	S	S	S	S	S			22,00 €
KIT DETERGENTE ALTA PRESIÓN	HI-46222	0	0	0	0	0	0	0	0	0	0	0	0			39,00 €
BOQUILLA DE ÁNGULOS 5 POSICIONES	HI-46230	0											0			39,00 €
BOQUILLA DE ÁNGULOS 5 POSICIONES	HI-46231		0									0				39,00 €
BOQUILLA DE ÁNGULOS 5 POSICIONES	HI-46232			0	0			0	0							39,00 €
BOQUILLA DE ÁNGULOS 5 POSICIONES	HI-46233					0				0						39,00 €
BOQUILLA DE ÁNGULOS 5 POSICIONES	HI-46234						0				0					39,00 €
BOQUILLA DE ÁNGULOS 5 POSICIONES	HI-46660												0	S		49,00 €

S = De serie

0 = Opcional

ARTÍCULO	REF.	MODELO DE MÁQUINA														OFERTA
		MPX 14E	MPX 16E	MPX 17EH	MPX 19EH	MPX 22EH	MPX 25EH	MPX 17EHDS	MPX 19EHDS	MPX 22EHDS	MPX 25EHDS	MPX 20EHX	MPX 22EHX	DTS25	DTS27	
LANZA MULTIFUCIÓN	HI-46225	0											0			49,00 €
LANZA MULTIFUCIÓN	HI-46226		0										0			49,00 €
LANZA MULTIFUCIÓN	HI-46227			0	0			0	0							49,00 €
LANZA MULTIFUCIÓN	HI-46228					0				0						49,00 €
LANZA MULTIFUCIÓN	HI-46229						0				0					49,00 €
KIT DESATASCO TUBERÍA 8 MT	HI-46190	0	0	0	0	0	0	0	0	0	0	0	0			69,00 €
KIT DESATASCO TUBERÍA 16 MT	HI-46191													0	0	89,00 €
CEPILLO	HI-46177	0	0	0	0	0	0	0	0	0	0	0	0	0	0	22,00 €
CEPILLO	HI-46178	0	0	0	0	0	0	0	0	0	0	0	0	0	0	22,00 €
CEPILLO ROTATIVO	HI-46179	0	0	0	0	0	0	0	0	0	0	0	0	0	0	32,00 €
CEPILLO DE SUELO 25 CM	HI-46196	0	0	0	0	0	0	0	0	0	0	0				69,00 €
CEPILLO SUELO CON REGULACIÓN 30 CM	HI-46197	0	0	0	0	0	0	0	0	0	0	0				99,00 €
KIT DE ARENA	HI-46180	0	0	0	0	0	0	0	0	0	0	0				119,00 €
KIT DE SUCCIÓN DE AGUA	HI-46181	0	0	0	0	0	0	0	0	0	0	0	0	0	0	79,95 €
ADAPTADOR DE BOQUILLAS	HI-46171	0	0	0	0	0	0	0	0	0	0	0	0	0	0	19,00 €
KIT EXTENSIÓN LANZA DE 1.6 MT	HI-46188	0	0	0	0	0	0	0	0	0	0	0	0	0	0	80,00 €
ADAPTADORES	HI-46184	0	0	0	0	0	0	0	0	0	0	0	0	0	0	22,00 €
KIT DE ADAPTADORES	HI-46224	0	0	0	0	0	0	0	0	0	0	0	0	0	0	29,00 €
FILTRO (3 UDS)	HI-46185	S	S	S	S	S	S	S	S	S	S	S	S	S	S	22,00 €
KIT FILTRO DE AGUA	HI-46186	0	0	0	0	0	0	0	0	0	0	0	0	0	0	22,00 €
ENCHUFE RÁPIDO	HI-46187	0	0	0	0	0	0	0	0	0	0	0	0	0	0	13,00 €

S = De serie

0 = Opcional

ARTÍCULO	REF.	MODELO DE MÁQUINA						OFERTA
		AR-1490	MPX210TH0	MPX210TL	MPX150HDC	MPX170HDC	MPX200HDK	
PISTOLA	HI-43524	S						49,00 €
PISTOLA	HI-43525		S					39,00 €
PISTOLA	HI-40925			S	S	S	S	49,00 €
PISTOLA	HI-41045							44,00 €
PISTOLA	HI-41046							44,00 €
MANGUERA	HI-1700980	S						149,00 €
MANGUERA	HI-3780493		S	S				69,00 €
MANGUERA	HI-1271960				S	S		149,00 €
MANGUERA	HI-1700980						S	149,00 €
LANZA	HI-3600650		S	S				39,00 €
LANZA	HI-3600340	S			S	S	S	39,00 €
BOQUILLA BAJA PRESIÓN	HI-3600400	S	S	S	S	S	S	12,00 €
BOQUILLA 15°	HI-3600360	S			S			12,00 €
BOQUILLA 25°	HI-3600370	S			S			12,00 €
BOQUILLA 40°	HI-3600380	S			S			12,00 €
BOQUILLA 15°	HI-3600490	S			S	S	S	12,00 €
BOQUILLA 25°	HI-3600500	S			S	S	S	12,00 €
BOQUILLA 40	HI-3600510	S			S	S	S	12,00 €
BOQUILLA 0°	HI-3600930		S	S				12,00 €
BOQUILLA 15°	HI-3600940		S	S				12,00 €
BOQUILLA 25°	HI-3600960		S	S				12,00 €
CEPILLO	HI-46177	0	0	0	0	0	0	22,00 €
SUCCIÓN AGUA (46181)	HI-41592	0	0	0	0	0	0	79,75 €
PATIO CLEANER 36CM	HI-46239	0	0	0	0	0	0	159 €
KIT DESATASCO TUBERÍA 8 MT	HI-46190	0	0	0	0	0	0	69,00 €
KIT DESATASCO TUBERÍA 16 MT	HI-46191	0	0	0	0	0	0	89,00 €

S = De serie

0 = Opcional

CA-MB1+11
1,5 HP - 230 V.
160 Lt/min
8 bar
Accesorios incluidos



89€

CA-MBL6/1100
1,5 HP - 230 V.
160 Lt/min - 8 bar
Sin aceite
Ref.:CA-1129581037
6 Lt.



125€

CA-MBL-60
Compresor+enrollador.
1,5 HP - 230 V
160 Lt/min - Sin Aceite
8 Bar 75 dB
2800 r.p.m.
Enrollador de 10 mt

Soporte de pared + Pistola de soplar



199€

CA-MX6-1
1 HP - 230 V.
106 Lt/min
8 bar
59 dB
6 Lt.

Silencioso



169€

CA-MX24-1
1 HP - 230 V.
106 Lt/min
8 bar
59 dB
24 Lt.

Silencioso



199€

CA-MB24
2 HP - 230 V.
170 Lt/min
8 bar
24 Lt.



189€

CA-MB50
2 HP - 230 V.
170 Lt/min
8 bar
50 Lt.



229€

CA-VCX50

3 HP - 230 V.
350 Lt/min
10 bar
72 dB
50 Lt.



640€

CA-VCX100

3 HP - 230 V.
350 Lt/min
10 bar
74 dB
100 Lt.



687€

CA-VCX150/3M

3 HP
380/230 V.
350 Lt/min
10 bar
74 dB
150 Lt.



809€

CA-VCX150/3T

3 HP
400 V.
350 Lt/min
10 bar
74 dB
150 Lt.



809€

CA-MCX300/514

5,5 HP - 380 V.
443 Lt/min
75 dB
270 Lt.

14 Bar



1.909€

CA-MCX300/598

5,5 HP - 380 V.
600 Lt/min - 10 bar
75 dB
270 Lt.



1.649€

CA-MCX500/808

7,5 HP - 380 V.
808 Lt/min - 10 bar
75 dB
500 Lt.



2.076€

CA-MCX500/998

10 HP - 380 V.
Estrella Triángulo
1.070 Lt/min - 10 bar
78 dB
500 Lt.



2.999€

CA-MCX500/814

7,5 HP - 380 V.
561 Lt/min
75 dB
500 lt.

14 Bar



2.499 €

CA-MCX500/1014

10 HP - 380 V.
Estrella Triángulo
831 Lt/min
78 dB
500 lt.

14 Bar



3.332 €

CA-MUX360/100

5 HP
350 Lt/min
10 bar
100 lt.

Motor gasolina

HONDA
GP160



1.199 €

CA-MUX515/200

5,5 HP
515 Lt/min
10 bar
200 lt.

Motor gasolina

HONDA
GX160



1.599 €

CA-MUX598/300

9 HP - HONDA GX270
600 Lt/min
10 bar
270 lt.

Motor gasolina

HONDA
GX270



2.499 €

44

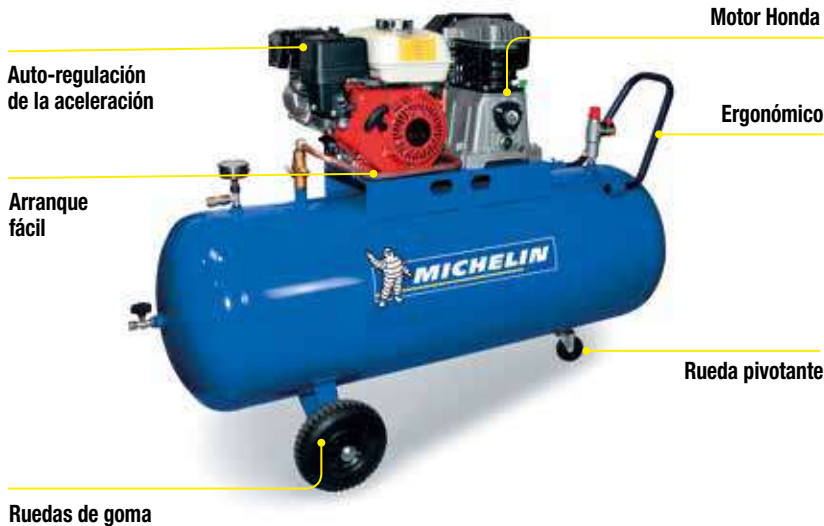

COMPRESORES INSONORIZADOS DE PISTÓN



CA-MCX598N

5,5 HP - 400 V.
600 l/min
10 bar. 68 dB



2.274€

CA-MCX958N

7,5 HP - 400 V.
830 l/min
10 bar. 66 dB



2.499€

CA-MCX998N

10 HP - 400 V.
1.070 l/min
10 bar. 66 dB



2.799€

CA-MCX598/300N

5,5 HP - 400 V.
598 l/min
10 bar. 68 dB
270 Lt.

Con caldera



3.275€

CA-MCX958/500N

7,5 HP - 400 V.
830 l/min
10 bar. 66 dB
500 Lt.

Con caldera



3.959€

CA-MCX998/500N

10 HP - 400 V.
1070 l/min
10 bar. 66 dB
500 Lt.

Con caldera



3.959€

CA-MCXD598/300N

5,5 HP - 400 V.
598 l/min
10 bar. 68 dB
270 Lt.

Con caldera
y secador



4.325€

CA-MCXD958/500N

7,5 HP - 400 V.
830 l/min
10 bar. 66 dB
500 Lt.

Con caldera
y secador



5.100€

CA-MCXD998/500N

10 HP - 400 V.
1070 l/min
10 bar. 66 dB
500 Lt.

Con caldera
y secador



5.375€

CA-1126000428

Kit de 66 piezas neumática.



149,33 €

CA-1126000738

Enrollador automático
10 m. Carcasa de metal
Ø 12 - 8 mm.



103 €

CAKITMICHELIN

Kit de aire profesional:
Pistola de soplar, pistola de
petroleo, pistola de pintar,
pistola de hinchar
y espiral.



37,04 €

CA-1126001367

Pistola neumática
de grasa. Cartucho
de 310 ml. Acople
1/4. 250-300 lt/min.
Tubo con cuatro
salidas. 4-6 Bar.
C.F.M. 4 87 PSI.

Usar con
lubricador 037



43,99 €

CA-1126001369

Llave criquet. Acople
1/4. Par de apriete
61 Nm. Tuerca M10.
120-160 lt/min. 6 Bar.
C.F.M. 4. 87 PSI.

Usar con
lubricador 037



87,98 €

CA-1126001363

Martillo cincelador.
170 lt/min. 6 Bar.

Usar con
lubricador 037



25,36 €

CA-1126000745

Lijadora roto
orbital
170 lt/min. 6 Bar.
Disco Ø125 mm
10.000 osc/min.
87 PSI.

Usar con
lubricador 037
Con disco de
velcro



98,40 €

CA-1126000742

Lijadora roto
orbital.
250 lt/min. 6 Bar.
Disco Ø150 mm.
10.000 osc/min
87 PSI.

Usar con
lubricador 037



63,67 €

CA-1126001368























Pistola de silicona.
Acople de 1/4".
170 lt/min. 6 Bar.
Cartuchos: 310 ml.
87 PSI.

Usar con
lubricador 037



52,09 €

REFERENCIA	DESCRIPCIÓN	OFERTA	REFERENCIA	DESCRIPCIÓN	OFERTA
CA-1126001508	Enchufe rápido universal para manguera de PVC y Poliuretano Ø 6mm	6,95 €	CA-1126001488	Tuerca fresada	6,34 €
CA-1126001509	Enchufe rápido universal para manguera de PVC y Poliuretano Ø 8mm	6,95 €	CA-1126001500	Conexión rápida para manguera Diam. 6 mm	3,47 €
CA-1126001512	Enchufe rápido universal rosca hembra 1/4"	6,95 €	CA-1126001501	Conexión rápida para manguera Diam. 8 mm	3,47 €
CA-1126001513	Enchufe rápido universal rosca hembra 3/8"	6,95 €	CA-1126001503	Conector rápido con cierre bayoneta.	4,63 €
CA-1126001511	Enchufe rápido universal rosca hembra 1/2"	6,95 €	CA-1126001504	Conector rápido rosca hembra. 1/4"	3,47 €
CA-1126001515	Enchufe rápido universal rosca macho 1/4"	5,79 €	CA-1126001505	Conector rápido rosca hembra. 3/8"	3,47 €
CA-1126001516	Enchufe rápido universal rosca macho 3/8"	5,79 €	CA-1126001506	Conector rápido rosca macho. 1/4"	4,13 €
CA-1126001475	Racor en Y hembra 1/4	6,34 €	CA-1126001507	Conector rápido rosca macho. 3/8"	4,13 €
CA-1126001476	Racor en Y macho 1/4 hembra 1/4	4,13 €	CA-1126001518	Purgador de 1/4	4,63 €
CA-1126001477	Racor en T hembra 1/4	5,79 €	CA-1126001520	Llave de paso macho - hembra 1/4	11,58 €
CA-1126001481	Reductor macho hembra 3/8 - 1/4	3,47 €	CA-1126001521	Llave de paso macho - hembra 3/8	11,58 €
CA-1126001478	Reductor macho hembra 1/2 - 1/4	3,47 €	CA-1126001522	Llave de paso macho 1/4"	7,50 €
CA-1126001480	Reductor macho hembra 1/2 - 3/8	3,47 €	CA-1126001527	Válvula de seguridad 1/4	7,28 €
CA-1126001483	Manguito rosca hembra 1/4-1/4	4,63 €	CA-1126001529	Manómetro diam. 50 16 Bar. Rosca posterior	12,73 €
CA-1126001484	Racor macho 1/4 -1/4	3,47 €	CA-1126001358	Presostato con válvula de arranque. 4x1/4" Hembra	19,00 €
CA-1126001485	Racor macho 3/8 -3/8	4,63 €			

REFERENCIA	DESCRIPCIÓN	OFERTA	REFERENCIA	DESCRIPCIÓN	OFERTA
CA-1126001361	 Mini lubricador	8,00 €	CA-1126001406	 Pistola de arenar con depósito inferior 1 lt.	32,00 €
CA-1126001433	 Filtro purificador 1/4	36,00 €	CA-6218500004	 Pistola de pintar con depósito inferior y cierre bayoneta. 1 lt. Ø Boquilla 1,5	35,00 €
CA-1126001434	 Lubrificador 1/4	42,00 €	CA-1126001422	 Pistola de pintar con depósito superior. 0,5 lt. Ø Boquilla 1,5	35,00 €
CA-1126001435	 Regulador de presión con manómetro. Dos salidas. 180l/min. 12bar 3/8"	44,00 €	CA-1126001423	 Pistola de pintar Prof. Depósito inferior. Cierre abrazaderas. 1 lt. Ø Boquilla 1,5. HVLP	92,00 €
CA-1126001436	 Regulador de presión con manómetro salida universal . 180 l/min. 12bar. 1/4"	21,00 €	CA-1126001426	 Pistola de pintar profesional con depósito superior. 0,5 lt. Ø Boquilla 1,5. HVLP	92,00 €
CA-1126001470	 Boquilla para inflado de neumáticos.	5,00 €	CA-1120009006	 Kit completo paso de fluido. Ø Boquilla 1,5 mm. Para mod. 1855- 1856	19,00 €
CA-1126001472	 Kit 3 boquillas de inflado	6,00 €	CA-1126001051	 Espiral completa con acople universal 5 mt. Diam. 6x8	16,00 €
CA-1126001055	 Pistola de soplar standard	9,00 €	CA-1126001395	 Espiral completa con acople universal 10 mt. Diam. 6x8	18,00 €
CA-1126001399	 Pistola de soplar con boquilla curva de plástico	11,00 €	CA-1126001387	 Manguera PVC 10 mt. con acoples universales. Ø 8x12mm. 20 bar.	26,00 €
CA-1126001400	 Pistola de soplar con boquilla larga	11,00 €	CA-1126001390	 Manguera PVC 20 mt. con acoples universales. Ø 8x12mm. 20 bar.	35,00 €
CA-1126001065	 Inflador de neumáticos 0-12 bar	19,00 €			
CA-1126001404	 Aspirador	39,00 €			
CA-1126001079	 Pistola de petroleo	27,00 €			

COMPRESOR



MODELO	Volt/Hz/Ph	dB	LT./MIN	CFM	m ₃ /h	BAR/Psi	HP	KW	KG	AXBXC (cm)
CA-RSX5,5	400/50/3	65	450	15,9	27	10/145	5,5	4	138	84,6x57,2x75
CA-RSX7,5	400/50/3	66	720	25,5	43,2	10/145	7,5	5,5	143	84,6x57,2x75
CA-RSX10	400/50/3	67	860	30,4	51,6	10/145	10	7,5	148	90x70x92
CA-RSX15	400/50/3	65	1430	50,5	85,8	10/145	15	11	270	82x54x75,9
CA-RSX20	400/50/3	67	1900	67,1	114	10/145	20	15	280	94x63x85
CA-RSX25	400/50/3	73	2500	88,4	150	10/145	25	18,5	468	100,5x88,4x118
CA-RSX30	400/50/3	74	2970	105	178,2	10/145	30	22	498	100,5x88,4x118
CA-RSX40	400/50/3	74	3900	137,9	234	10	40	40	679	89x120x135
CA-RSX50	400/50/3	75	5000	176,8	300	10	50	50	700	89x120x135
CA-RSX75	400/50/3	74	7900	279,3	474	10	75	55	1.230	128,5x168x164

Todos los compresores son trifásicos.

CONSULTAR PRECIOS

COMPRESOR CON SECADOR



MODELO	Volt/Hz/Ph	dB	LT./MIN	CFM	m ₃ /h	BAR/Psi	HP	KW	KG	AXBXC
CA-RSXD5,5	400/50/3	65	450	15,9	27	10/145	5,5	4	160	90x70x92
CA-RSXD7,5	400/50/3	66	720	25,5	43,2	10/145	7,5	5,5	165	90x70x92
CA-RSXD10	400/50/3	67	860	30,4	51,6	10/145	10	7,5	175	90x70x92
CA-RSXD15	400/50/3	65	1430	50,5	85,8	10/145	15	11	270	118x76x100
CA-RSXD20	400/50/3	67	1900	67,1	114	10/145	20	15	280	89x76x135
CA-RSXD25	400/50/3	73	2500	88,4	150	10/145	25	18,5	468	100,5x88,4x118
CA-RSXD30	400/50/3	74	2970	105	178,2	10/145	30	22	498	100,5x88,4x118

CONSULTAR PRECIOS

COMPRESOR CON CALDERA

Cabina insonorizada

Panel de Control

Manómetro tanque

Botón de parada de emergencia

Drenaje condensación



MODELO	Volt/Hz/Ph	LITROS	dB	LT./MIN	CFM	m ³ /h	BAR/Psi	HP	KW	KG	AXBXC
CA-RSX3/100M	230/50/1	90	59	300	10,6	18	9/130	3	2,2	84	110x52x125
CA-RSX3/100TR	380/50/3	90	59	300	10,6	18	9/130	3	2,2	135	100x52x125
CA-RSX5,5/300	400/50/3	270	65	450	15,9	27	10/145	5,5	4	205	163,1x57,2x127,4
CA-RSX7,5/500	400/50/3	500	66	720	25,5	43,2	10/145	7,5	5,5	255	203,8x60x136,7
CA-RSX10/500	400/50/3	500	67	860	30,4	51,6	10/145	10	7,5	260	203,8x60x136,7
CA-RSX15/500	400/50/3	500	65	1430	50,5	85,8	10/145	15	11	349	203,8x70x144,6
CA-RSX20/500	400/50/3	500	67	1900	67,1	114	10/145	20	15	392	203,8x70x144,6
CA-RSX25/500	400/50/3	500	73	2500	88,4	150	10/145	25	18,5	670	203,8x88,4x179
CA-RSX30/500	400/50/3	500	74	2970	105	178,2	10/145	30	22	700	203,8x88,4x179

50

CONSULTAR PRECIOS

COMPRESOR CON SECADOR Y CALDERA

Cabina insonorizada

Panel de Control

Botón de parada de emergencia

Drenaje condensación



MODELO	Volt/Hz/Ph	LITROS	dB	LT./MIN	CFM	m ³ /h	BAR/Psi	HP	KW	KG	AXBXC
CA-RSXD5,5/300	400/50/3	270	65	450	15,9	27	10/145	5,5	4	245	163,1x57,2x127,4
CA-RSXD7,5/500	400/50/3	500	66	720	25,5	43,2	10/145	7,5	5,5	295	163,1x57,2x127,4
CA-RSXD10/500	400/50/3	500	67	860	30,4	51,6	10/145	10	7,5	300	203,8x60x136,7
CA-RSXD15/500	400/50/3	500	65	1430	50,5	85,8	10/145	15	11	390	203,8x70x144,6
CA-RSXD20/500	400/50/3	500	67	1900	67,1	114	10/145	20	15	438	203,8x70x144,6
CA-RSXD25/500	400/50/3	500	73	2500	88,4	150	10/145	25	18,5	670	203,8x88,4x179
CA-RSXD30/500	400/50/3	500	74	2970	105	178,2	10/145	30	22	700	203,8x88,4x179

CONSULTAR PRECIOS

SECADORES FRIGORÍFICOS TDRY

MODELO	CÓDIGO	LT./MIN	CFM	m ³ /h	MBAR	BSP	C° L	LxPxH cm.	KG	OFERTA
CA-TDRY4	4102002780	350	12	21	0,15	3/4" M	4	350x493x450	19	922,86 €
CA-TDRY6	4102002781	600	21	36	0,25	3/4" M	4	350x493x450	19	1.092,23 €
CA-TDRY9	4102002782	850	30	51	0,25	3/4" M	4	350x493x450	20	1.231,20 €
CA-TDRY12	4102002783	1200	42	72	0,25	3/4" M	4	350x493x450	25	1.318,06 €
CA-TDRY18	4102002784	1825	64	110	0,30	3/4" M	4	350x493x450	27	1.461,37 €
CA-TDRY24	4102003277	2350	83	141	0,32	1"	4	370x498x764	44	1.569,94 €
CA-TDRY30	4102003278	3000	106	180	0,38	1"	4	370x498x764	44	1.978,17 €



CALDERAS VERTICALES LT

- Equipado con válvula de seguridad CE.
- Válvula manual de drenaje de condensado.
- Manómetro
- Salida de aire

MODELO	CÓDIGO	LITROS	Ø	BAR	PSI	ØXAlto (mm.)	OFERTA
CA-LT270CE	1121710100	270	3/4"	11	160	540x1950	500 €
CA-LT500CE	1121710101	500	3/4"	11	160	666x2160	915 €
CA-LT720CE	1121710102	720	3/4"	11	160	800x2070	1.050 €
CA-LT900CE	1121710124	900	1"	11	160	800x2115	1.200 €



FILTROS

FQ 1000 ÷ 40000 (3 µ) 3 MICRAS.

MODELO	CÓDIGO	LT./MIN	LT/S	m ₃ /h	SCFM	CONEXIÓN	OFERTA
FQ 1000	FP 4	900	15	54	32	G3/8"	174 €
FQ 1300	FP 5	1416	24	85	50	G1/2"	187 €
FQ 2000	FP 6	1986	33	119	70	G1/2"	210 €
FQ 3300	FP 9	3534	59	212	125	G3/4"	295 €
FQ 5600	FP 10	4950	83	297	175	G1"	305 €
FQ 8500	FP 12	9084	151	545	321	G1- 1/2"	448 €
FQ 13000	FP 13	12750	213	765	450	G2"	635 €

Líquido
Polvo



FP 1000 ÷ 40000 (1 µ - 0,1 mg/m³)

LÍQUIDO/POLVO 0,1 MICRA ACEITE 0,1 mg/m³

MODELO	CÓDIGO	LT./MIN	LT/S	m ₃ /h	SCFM	CONEXIÓN	OFERTA
FP 1000	FG 4	900	15	54	32	G3/8"	174 €
FP 1300	FG 5	1416	24	85	50	G1/2"	187 €
FP 2000	FG 6	1986	33	119	70	G1/2"	210 €
FP 3300	FG 9	3534	59	212	125	G3/4"	295 €
FP 5600	FG 10	4950	83	297	175	G1"	305 €
FP 8500	FG 12	9084	151	545	321	G1- 1/2"	448 €
FP 13000	FG 13	12750	213	765	450	G2"	635 €

Líquido
Polvo
Aceite



FD 1000 ÷ 40000 (0,01 µ - 0,01 mg/m³)

LÍQUIDO/POLVO 0,01 MICRA. ACEITE 0,01 mg/m³

MODELO	CÓDIGO	LT./MIN	LT/S	m ₃ /h	SCFM	CONEXIÓN	OFERTA
FD 1000	FC 4	900	15	54	32	G3/8"	174 €
FD 1300	FC 5	1416	24	85	50	G1/2"	187 €
FD 2000	FC 6	1986	33	119	70	G1/2"	210 €
FD 3300	FC 9	3534	59	212	125	G3/4"	295 €
FD 5600	FC 10	4950	83	297	175	G1"	305 €
FD 8500	FC 12	9084	151	545	321	G1- 1/2"	448 €
FD 13000	FC 13	12750	213	765	450	G2"	635 €

Líquido
Polvo
Aceite



FILTROS

FC 1000 ÷ 40000 (0,003 µ)

MODELO	CÓDIGO	LT./MIN	LT/S	m ³ /h	SCFM	CONEXIÓN	OFERTA
FC 1000	FV 4	900	15	54	32	G3/8"	174 €
FC 1300	FV 5	1416	24	85	50	G1/2"	187 €
FC 2000	FV 6	1986	33	119	70	G1/2"	210 €
FC 3300	FV 9	3534	59	212	125	G3/4"	295 €
FC 5600	FV 10	4950	83	297	175	G1"	305 €
FC 8500	FV 12	9084	151	545	321	G1- 1/2"	448 €
FC 13000	FV 13	12750	213	765	450	G2"	635 €



Aceite



PURGADOR AUTOMÁTICO AIRTEC 1/2"

CA1127560559

Para compresor de tornillo

Programable



315 €

PURGADOR AUTOMÁTICO AIRTEC 1/8"

CA1127560108

Para compresor de correas.

Con caldera



99 €

MEZCLADORES

CE-M1201PRO

1200 W.
Volumen
mezcla 40 Lt.
150-300 r.p.m.
300-650 r.p.m.
Regulación
electrónica

95 €



CE-M1600PRO

1600 W.
Volumen
mezcla 120 Lt.
210-390 r.p.m.
350-650 r.p.m.
Regulación
electrónica

109 €



2 velocidades

CE-MX1601N

1600 W.
Volumen mezcla
120 Lt.
150-300 r.p.m.
300-650 r.p.m.
Regulación
electrónica

2 velocidades
Uso profesional



155 €



CE-MX1801N

1800 W.
Volumen mezcla
140 Lt.
150-300 r.p.m.
300-650 r.p.m.
Regulación
electrónica

2 velocidades
Uso profesional



169 €



54

CE-M900R

850 W.
Volumen
mezcla 40 Lt.
0-550 r.p.m.
M14

65 €



VARILLAS PARA BATIDORA

CE-H2A - 120x600 mm. - M14 : CE-H3B - 140x600 mm. - M14
CE-H2B - 140x600 mm. - M14 : CE-H5B - 140x600 mm. - M14
CE-H3A - 120x600 mm. - M14 :

UD. DESDE

15 €



H2



H3



H5

VARILLAS PARA TALADRO

CE-VARILLA 80X400
CE-VARILLA 100X600

UD. DESDE

3 €



DECAPADORES

CE-GW1026M

2000 W. 50-550 °C
2 velocidades
300 - 500 Lt/min
6 accesorios.



23€

CE-GW1029M

2000 W. 50-600 °C
2 velocidades
300 - 500 Lt/min
9 accesorios.



37€

Sistema de
enfriamiento
Display LCD

CE-GW1030M

2000 W. 50-600 °C
2 velocidades
200 - 500 Lt/min
9 accesorios.



49€

Display
digital

ASPIRADORES

CP31-501

2200 W.
Depósito 30 Lt.
Regulación
electrónica
Acc. incluidos



309€

Especial pintura
Telecomandado
Aspira sólidos y
líquidos
Filtro de agua

CE-PRO20X

1250 W.
Caudal aire:
58 Lt/s
Depósito: 20 Lt.
Acc. incluidos



99€

Depósito acero inox.
Aspira sólidos y líquidos

CE-PRO30XT

1400 W.
Caudal aire:
58 Lt/s
Depósito: 30 Lt.
Acc. incluidos



149€

Depósito acero
inox.
Telecomandado
Aspira sólidos y
líquidos

CE-PRO50XT

1.400 W.
Caudal aire:
58 Lt/s
Depósito: 50 Lt.
Acc. incluidos



199€

Depósito acero
inox.
Telecomandado
Aspira sólidos y
líquidos

ASPIRADORES

CE-PRO70ABS

1200 W.
Caudal aire: 215 m3/h.
Depósito: 77 Lt.
65 dB.
Acc. incluidos



Depósito
Polipropileno
Aspira sólidos
y líquidos

399€

CE-PRO703INOXTR

2900 W.
Caudal aire: 510 m3/h.
Depósito: 77 Lt.
Acc. incluidos



Depósito
acero inox.
3 motores
Aspira sólidos
y líquidos

579€

CE-PRO703ABS

2900 W.
Caudal aire: 510 m3/h.
Depósito: 77 Lt. 68 dB.
Acc. incluidos



599€

Depósito
Polipropileno
3 motores
Aspira sólidos
y líquidos



ACCESORIOS ASPIRADORES

MODELO	CP31-501	PRO20X	PRO30XT	PRO50XT	PRO70ABS	PRO703INOX	PRO703ABS
BOLSA	CP31-501BOLSA	AS1001	AS1001	AS1002	FI005C	FI005C	FI005C
	24,00 €	14,00 €	14,00 €	15,00 €	14,00 €	14,00 €	14,00 €
FILTRO SÓLIDO	CP31-501FP	AS1008	AS1008	AS1008	FA044P	FA044P	FA044P
	21,00 €	16,00 €	16,00 €	16,00 €	48,00 €	48,00 €	48,00 €
FILTRO LÍQUIDO	CP31-501FA	AS1005	AS1005	AS1005	ACCA165A	ACCA165A	ACCA165A
	13,00 €	12,00 €	12,00 €	12,00 €	14,00 €	14,00 €	14,00 €
MANGUERA	CP31-501-52	AS1001PRO	AS1001PRO	AS1001PRO	CE-ACTF38/2.5/C	CE-ACTF38/2.5/C	CE-ACTF38/2.5/C
	13,00 €	10,00 €	10,00 €	10,00 €	34,00 €	34,00 €	34,00 €
PROLONGADOR PLÁSTICO		AS1002AKP	AS1002AKP	AS1002AKP			
		7,00 €	7,00 €	7,00 €			
PROLONGADOR METÁLICO		AS1004EKP	AS1004EKP	AS1004EKP	ACTC038D	ACTC038D	ACTC038D
		15,00 €	15,00 €	15,00 €	39,00 €	39,00 €	39,00 €
BOQUILLA		AS1009EKB	AS1009EKB	AS1009EKB	CE-ACLP040	CE-ACLP040	CE-ACLP040
		6,50 €	6,50 €	6,50 €	5,00 €	5,00 €	5,00 €
CEPILLO MULTIUSO		AS1004EKB	AS1004EKB	EKB1002			
		8,00 €	8,00 €	8,00 €			
SOPORTE CEPILLO					ACCS400A/P	ACCS400A/P	ACCS400A/P
					13,00 €	13,00 €	13,00 €
CEPILLO LÍQUIDOS					ACIL400	ACIL400	ACIL400
					12,50 €	12,50 €	12,50 €
CEPILLO SUELOS					ACIP400	ACIP400	ACIP400
					12,00 €	12,00 €	12,00 €
CEPILLO REDONDO 40					ACPE040	ACPE040	ACPE040
					6,00 €	6,00 €	6,00 €

LIJADORAS

CP31-750

Lijadora de pared
750 W. Ø Disco lija 225 m.
6 velocidades
Telescópica:
110/180 cm.



199 €

Ref.: CP31-7502
Plato espuma velcro
P.V.P.:20,00€

CP31-1100

Lijadora de pared
1010 W. Ø Disco lija 225 m.
6 velocidades.



119 €

Ref.: CP31-1111
Plato triangular
P.V.P.:35,20 €

HV651

Equipo de pintar. 280 W.
Depósito 600 ml.
Viscosidad máx. 90 Din/sec

3 posiciones



59 €

CP31-400

Lijadora roto orbital
230-240 V.
Ø lija 150 mm.
400 - 10000 r.p.m.

Motor "Brushless"
Orbita 5 mm.



209 €

Plato de goma
Ø 150 mm.
Ref.: NE-RP7336S1BIS
P.V.P.:35,00 €

CP31-401

Lijadora roto orbital
230-240 V.
Ø lija 150 mm.
400 - 10000 r.p.m.

Motor "Brushless"
Orbita 2,5 mm.



209 €

Plato de goma
Ø 150 mm.
Ref.: NE-RP7336S1BIS
P.V.P.:35,00 €

57

DISCOS DE LIJA

Discos de lija con velcro de gran calidad. 15 agujeros.
Válidos para modelos CP31-400 / CP31-401

Ø 150 mm.

ARTICULO	GRANO	OFERTA	ARTICULO	GRANO	OFERTA	ARTICULO	GRANO	OFERTA
I-CARVF402040	40	0,57 €	I-CARVF402150	150	0,37 €	I-CARVF402320	320	0,37 €
I-CARVF402060	60	0,52 €	I-CARVF402180	180		I-CARVF402400	400	
I-CARVF402080	80	0,45 €	I-CARVF402220	220		I-CARVF402500	500	
I-CARVF402100	100	0,41 €	I-CARVF402240	240		I-CARVF402600	600	
I-CARVF402120	120	0,41 €	I-CARVF402280	280		I-CARVF402800	800	

Cajas completas (100/50 uds.)

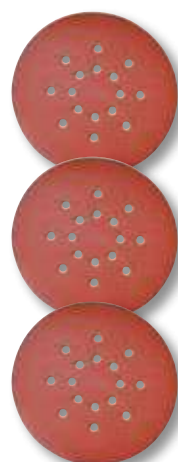

TALADROS DE COLUMNA

CP12-921
350 W.
Capacidad de la broca 1,5 - 13 mm.
Altura: 580 mm.
Portabrocas B13



Portabrocas llave
Mordaza

139 €

CP12-941
450 W.
Capacidad de la broca 3 - 16 mm.
Altura: 840 mm.
Portabrocas B16



Portabrocas automático
Mordaza

275 €

CP12-951
550 W.
Capacidad de la broca 23 MT2 (*)
(Brocas cónicas)
Altura: 980 mm.
Portabrocas B16



Portabrocas automático
Mordaza

399 €

CP12-953
750 W.
Capacidad de la broca 28 MT3 (*)
(Brocas cónicas)
Altura: 1600 mm.
Portabrocas B22



Portabrocas automático
Mordaza

499 €

CP12-961
1500 W.
Capacidad de la broca 32 MT4 (*)
(Brocas cónicas)
Altura: 1710 mm.
Portabrocas B22



Portabrocas automático
Mordaza

999 €

PORTABROCAS

Para taladros de columna.

REFERENCIA	OFERTA
CP12-903 (B13 de 1.5 a 13 mm.)	24,00 €
CP12-904 (B16 de 3 a 16 mm.)	35,00 €
CP12-909 (B22 de 5 a 20 mm.)	41,00 €

MORDAZAS

Para taladros de columna.

MORDAZAS	OFERTA
CP12-906 (55 mm.)	18,00 €
CP12-901 (100 mm.)	18,00 €
CP12-902 (150 mm.)	35,00 €



(*) 23 MT2: Brocas cónicas de 15 a 23 mm.
(*) 28 MT3: Brocas cónicas de 23 a 28 mm.

POLIPASTOS



CE-P125-250

Polipasto. 540 W.
125/250 Kg. Largo cable:
12,5/6,25 m.



129 €

CE-P250-500

Polipasto. 1020 W.
250/500 Kg. Largo cable:
18,5/9,25 m.



179 €

CE-P500-990

Polipasto. 600 W.
500/990 Kg. Largo cable:
12,5/6,25 m.



339 €

59

CE-B750

Bandera para polipasto
• 250 Kgs. MÁX.
• Largo bandera 750 mm.
• Ángulo de rotación
180 grados.



49,50 €

CE-B1100

Bandera para polipasto
• 600 Kgs. MÁX.
• Largo bandera 1.100 mm.
• Ángulo de rotación
180 grados.

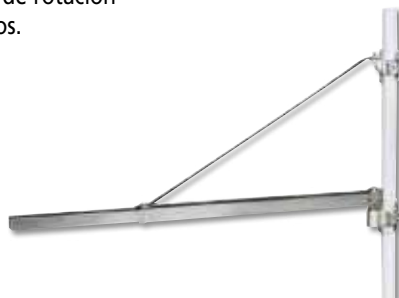

55 €

ESMERILADORAS

CE-E25/150

Esmeriladora doble muela
Ø 150 mm. 150 W.
2.900 r.p.m.



55€

CP10-200

Esmeriladora doble muela
Ø 200 mm. 500 W.
2.950 r.p.m.



85€

CP10-150AGUA

Esmeriladora afiladora
de agua. Motor 400 W.
2.950 r.p.m.

Doble muela



85€

CP10-150LIJA

Esmeriladora lijadora.
Motor 450 W.
2.950 r.p.m.

2 en 1



95€

60

ACCESORIOS

MORDAZAS	OFERTA
CE-MUELAAGUA200	63,00 €
CE-MUELA150GR36	19,00 €
CE-MUELA150GR60	19,00 €
CE-MUELA200GR36	21,00 €
CE-MUELA200GR60	21,00 €
IMBANDA50X680	15,00 €





LIJAS

TACO ABRASIVO

Granos fino, medio y grueso.



UNIDAD
0,59€

Pack 5 uds.

MSE-TFINOPACK P.V.P.: 2,69 €

MSE-TMEDIOPACK P.V.P.: 2,69 €

ESPONJA ABRASIVA

Granos fino, medio y grueso.



UNIDAD
0,59€

Pack 5 uds.

MSE-EFINOPACK P.V.P.: 2,69 €

MSE-EMEDIOPACK P.V.P.: 2,69 €

TACO ANGULO ABRASIVO

Granos fino, medio y grueso.



UNIDAD
0,79€

PLIEGOS MSE-SIM

Lija para madera, soporte papel, adhesivo cola, abrasivo silice.

Granos 60-80-100-120-150-180

Madera



UNIDAD
0,17€

* Cajas de 50 unidades.

PLIEGOS MSE-CRD

Lija para pared, soporte papel, adhesivo cola, abrasivo óxido de aluminio.

Granos 40-60-80-120-150.

Pared y madera



UD. DESDE
0,38€

* Cajas de 50 unidades.

PLIEGOS MSE-ASS

Lija para pared, soporte papel-latex, adhesivo cola abrasivo corindón + estearato.

Granos 80-180-280

320-400.

Pintura y lacas



UD. DESDE
0,38€

* Cajas de 100 unidades.

PLIEGOS MSE-FE

Lija para metal, soporte tela, adhesivo cola abrasivo corindón óxido de aluminio.

Granos 40-60-100-220-320.

Metal



UNIDAD
0,45€

* Cajas de 50 unidades.

PLIEGOS MSE-WEC

Lija al agua, soporte papel-latex, adhesivo cola abrasivo corindón + estearato.

Granos 180-220-280-360-500-800-2000.

Al agua



UD. DESDE
0,49€

* Cajas de 100 unidades.

PLIEGOS MSE-IMJ

Pliego de lija, soporte tela abrasiva, extra flexible al corindón, adhesivo doble resina, abrasivo corindón, óxido de aluminio.

Granos 60-80-120-180.

Madera dura y metal



UNIDAD
0,73€

* Cajas de 50 unidades.

LIJAS

BLISTERS

Papel abrasivo al Corindón, resina sobre cola, esparcimiento semiabierto. Soporte papel. Para pulir madera basta, barnices sobre madera y metal.

93 x 230 mm.
Lote 10 lijas.
8 agujeros.



REFERENCIA	GRANO	OFERTA
IMP3128	50	2,92 €
IMP3129	80	
IMP3130	120	
IMP3131	180	

115 x 280 mm.
Lote 10 lijas. Ciego



REFERENCIA	GRANO	OFERTA
IMP3108	50	3,50 €
IMP3109	80	
IMP3110	120	
IMP3111	180	

115 x 280 mm.
Lote 10 lijas.
8 agujeros.



REFERENCIA	GRANO	OFERTA
IMP3100	50	4,08 €
IMP3101	80	3,50 €
IMP3102	120	
IMP3103	180	

115 x 280 mm.
Lote 10 lijas.
14 agujeros.



REFERENCIA	GRANO	OFERTA
IMP3104	50	4,08 €
IMP3105	80	3,50 €
IMP3106	120	
IMP3107	180	

93 x 185 mm.
Lote 6 lijas.
8 agujeros.



REFERENCIA	GRANO	OFERTA
IMP3112	40	4,20 €
IMP3113	60	
IMP3114	80	
IMP3115	120	

93 x 185 mm.
Lote 6 lijas.
8 agujeros.



REFERENCIA	GRANO	OFERTA
IMP3116	50	4,20 €
IMP3117	80	
IMP3118	120	
IMP3119	180	

62



93 x 230 mm.
Lote 10 lijas. Ciego



REFERENCIA	GRANO	OFERTA
IMP3132	50	2,92 €
IMP3133	80	
IMP3134	120	
IMP3135	180	

93 x 230 mm.
Lote 10 lijas.
8 agujeros.

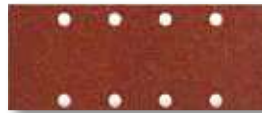

REFERENCIA	GRANO	OFERTA
IMP3124	50	2,92 €
IMP3125	80	
IMP3126	120	
IMP3127	180	

RETRÁCTIL

MSE-CRD93X230AS
Lote 10 lijas. 8 agujeros.
Granos surtidos. 93 x 230 mm.



1,75€



LIJAS

BLISTERS

93x93 mm.
6 unidades.



REF.	GRANO	OFERTA
IMP3140	50	2,41 €
IMP3141	80	2,16 €
IMP3142	120	2,10 €
IMP3143	180	2,16 €



RETRÁCTIL

93x93 mm.
6 unidades.



REFERENCIA	GRANO	OFERTA
MSEDELTA93GR60	60	1,63 €
MSEDELTA93GR80	80	
MSEDELTA93GR120	120	
MSEDELTA93GR180	180	



105 x 175 mm.
5 unidades.



REF.	GRANO	OFERTA
IMP3170	50	3,11 €
IMP3171	80	3,21 €
IMP3172	120	
IMP3173	180	



95x135 mm.
5 unidades.



REFERENCIA	GRANO	OFERTA
MSE95x135GR60	60	1,63 €
MSE95x135GR80	80	
MSE95x135GR120	120	
MSE95x135GR180	180	



100 x 150 mm.
6 unidades.



REF.	GRANO	OFERTA
IMP3148	50	5,03 €
IMP3149	80	4,66 €
IMP3150	120	4,43 €
IMP3151	180	



102x152 mm.
5 unidades.



REFERENCIA	GRANO	OFERTA
MSE102GR60	60	1,63 €
MSE102GR80	80	
MSE102GR120	120	
MSE102GR180	180	



DISCO OXY 180 mm.

6 unidades. Pulido de calidad. Para madera, pintura, cuero, resinas.



REFERENCIA	GRANO	OFERTA
OXYDF18040	40	4,96 €
OXYDF18080	80	4,84 €
OXYDF180120	120	4,66 €
OXYDF180180	180	4,96 €
OXYDF180ASS	VARIOS	

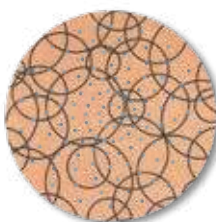

DISCO MALLA 150 mm.

5 unidades.



REFERENCIA	GRANO	OFERTA
MSE-150RTVB60	60	7,75 €
MSE-150RTVB80	80	
MSE-150RTVB120	120	
MSE-150RTVB180	180	



DISCO OXY 225 mm.

6 unidades. Pulido de calidad. Para madera, pintura, cuero, resinas.



REFERENCIA	GRANO	OFERTA
OXYDF22540	40	4,96 €
OXYDF22560	60	4,96 €
OXYDF22580	80	4,84 €
OXYDF225100	100	4,84 €
OXYDF225120	120	4,66 €
OXYDF225150	150	4,66 €
OXYDF225180	180	4,66 €
OXYDF225220	220	4,66 €
OXYDF225240	240	4,66 €

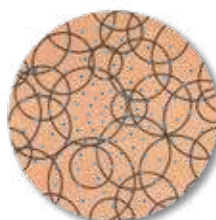

DISCO MALLA 225 mm.



5 unidades.



REFERENCIA	GRANO	OFERTA
MSE-225RTVB60	60	8,10 €
MSE-225RTVB80	80	
MSE-225RTVB120	120	
MSE-225RTVB180	180	



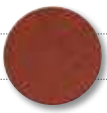

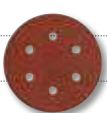
LIJAS BLISTERS

Discos ø 115 mm. Ciego (6 unid.) - VELCRO		OFERTA
IMP3152	Grano 50.	 2,57 €
IMP3153	Grano 80.	
IMP3154	Grano 120.	
Discos ø 125 mm. 8 agujeros (10 unid.) - VELCRO		OFERTA
IMP3155	Grano 50.	 2,74 €
IMP3156	Grano 80.	
IMP3157	Grano 120.	
IMP3158	Grano 180.	
Discos ø 127 mm. 1 agujero (10 unid.)		OFERTA
IMP3163	Grano 50.	 2,45 €
IMP3164	Grano 80.	
IMP3165	Grano 120.	
Discos ø 150 mm. 6 agujeros (6 unid.) - VELCRO		OFERTA
IMP3166	Grano 50.	 3,38 €
IMP3167	Grano 80.	
IMP3168	Grano 120.	

RETRÁCTIL

Discos ø 115 mm. 8 agujeros (6 unid.) - VELCRO		OFERTA
MSEDF11540	Grano 40.	 2,33 €
MSEDF11560	Grano 60.	
MSEDF11580	Grano 80.	
MSEDF115120	Grano 120.	
MSEDF115180	Grano 180.	
Discos ø 125 mm. 8 agujeros (6 unid.) - VELCRO		
MSEDF12540	Grano 40.	 2,33 €
MSEDF12560	Grano 60.	
MSEDF12580	Grano 80.	
MSEDF125120	Grano 120.	
MSEDF125180	Grano 180.	
Discos ø 150 mm. 8 agujeros (6 unid.) - VELCRO		OFERTA
MSEDF15040	Grano 40.	 3,21 €
MSEDF15060	Grano 60.	
MSEDF15080	Grano 80.	
MSEDF150120	Grano 120.	
MSEDF150180	Grano 180.	
Discos ø 150 mm. Ciego (6 unid.) - VELCRO		OFERTA
MSEDNF15060	Grano 60.	 3,21 €
MSEDNF15080	Grano 80.	
MSEDNF150120	Grano 120.	
MSEDNF150180	Grano 180.	

RETRÁCTIL

ARTÍCULO	RETRÁCTIL	OFERTA
LOTE 3 Bandas 75x457 mm		
MSE75X457	Disponibles en grano 40 - 60 - 80 - 120	 2,92 €
LOTE 3 Bandas 75x533 mm		
MSE75X533	Disponibles en grano 40 - 60 - 80 - 120	 2,92 €
LOTE 3 Bandas 100x610 mm		
MSE100X610	Disponibles en grano 40 - 60 - 80 - 100 - 120	 4,31 €

ARTÍCULO	RETRÁCTIL	OFERTA
LOTE 3 Bandas 100x690 mm		
MSE100X690	Disponibles en grano 40 - 60 - 80 - 100 - 180	 4,08 €
LOTE 3 Bandas 100x914 mm		
MSE100X914	Disponibles en grano 60 - 80 - 120 - 180	 9,91 €



LIJAS BLISTER

ARTÍCULO	GRANO	BLISTER	OFERTA
LOTE 3 Bandas 65x410 mm			
IMP3194	GR40		3,50 €
IMP3195	GR60		
IMP3196	GR80		
IMP3197	GR120		
IMP3198	GR180		
LOTE 3 Bandas 60x400 mm			
IMP3189	GR40		3,50 €
IMP3190	GR60		
IMP3191	GR80		
IMP3192	GR120		
IMP3193	GR180		
LOTE 3 Bandas 75x457 mm			
IMP3199	GR40		3,99 €
IMP3200	GR60		
IMP3201	GR80		
IMP3202	GR120		
IMP3203	GR180		
LOTE 3 Bandas 75x480 mm			
IMP3204	GR40		4,17 €
IMP3205	GR60		4,17 €
IMP3206	GR80		4,17 €
IMP3207	GR120		4,18 €
IMP3208	GR180		4,18 €
LOTE 3 Bandas 75x510 mm			
IMP3209	GR40		4,20 €
IMP3210	GR60		
IMP3211	GR80		
IMP3212	GR120		
IMP3213	GR180		

ARTÍCULO	GRANO	BLISTER	OFERTA
LOTE 3 Bandas 75x533 mm			
IMP3214	GR40		4,51 €
IMP3215	GR60		4,51 €
IMP3216	GR80		4,51 €
IMP3217	GR120		4,52 €
IMP3218	GR180		4,52 €
LOTE 3 Bandas 105x620 mm			
IMP3219	GR40		4,66 €
IMP3220	GR60		
IMP3221	GR80		
IMP3222	GR120		
IMP3223	GR180		
LOTE 3 Bandas 100x560 mm			
IMP3174	GR40		6,02 €
IMP3175	GR60		
IMP3176	GR80		
IMP3177	GR120		
IMP3178	GR180		
LOTE 3 Bandas 100x610 mm			
IMP3179	GR40		5,71 €
IMP3180	GR60		
IMP3181	GR80		
IMP3182	GR120		
IMP3183	GR180		
LOTE 3 Bandas 100x690 mm			
IMP3184	GR40		5,95 €
IMP3185	GR60		
IMP3186	GR80		
IMP3187	GR120		
IMP3188	GR180		



LIJAS

ROLLOS LIJA PARED (115 mm.) CRD

Soporte **papel**, adhesivo cola, abrasivo óxido de aluminio.

Madera dura y metal

REFERENCIA	GRANO	OFERTA
MSE-CRD115x560	60	2,92 €
MSE-CRD115x580	80	
MSE-CRD115x5120	120	
MSE-CRD115x5180	180	

5 mt.



REFERENCIA	GRANO	OFERTA
MSE-CRD115x2560	60	13,99 €
MSE-CRD115x2580	80	
MSE-CRD115x2512	120	
MSE-CRD115x2518	180	

25 mt.



ROLLOS LIJA MULTIPRODUCTO (120 mm.) IMJ

Soporte de tela abrasiva, extra flexible al corindón, adhesivo doble resina, abrasivo corindón, óxido de aluminio.

Madera dura y metal

REFERENCIA	GRANO	OFERTA
MSE-IMJ115x560	60	10,49 €
MSE-IMJ115x580	80	
MSE-IMJ115x5120	120	
MSE-IMJ115x5180	180	

5 mt.



REFERENCIA	GRANO	OFERTA
IM-213040	40	60,63 €
IM-213060	60	54,80 €
IM-213080	80	
IM-2130100	100	48,97 €
IM-2130120	120	
IM-2130150	150	54,80 €
IM-2130180	180	
IM-2130240	240	

25 mt.



ROLLO LIJA BARNIZ

(100 mm.) CCB

Soporte **papel**. Óptimo para la lijadura y acabado en seco de barnices de poliéster y transparentes.

3 mt.



REFERENCIA	GRANO	OFERTA
IM-12449661	180	2,62 €
IM-12449675	240	
IM-12449696	280	
IM-12449724	320	

ROLLO LIJA FLEXIBLE

MADERA (100 mm.) PTK

Soporte "J Flex". Tela. Elaboraciones manuales de estampados metálicos y acabados calidad standard.

3 mt.



REFERENCIA	GRANO	OFERTA
IM-12449605	180	5,25 €
IM-12449626	240	
IM-12449633	280	6,12 €
IM-12449654	320	

ROLLO LIJA VELCRO

(100 mm.) E28V

Soporte **papel**. Ideal para elaboraciones manuales sobre madera, materias plásticas y láminas metálicas, barnices sobre madera y metal.

3 mt.



REFERENCIA	GRANO	OFERTA
IM-12449864	40	7,58 €
IM-12449885	80	
IM-12449906	100	5,83 €
IM-12449913	150	

ROLLO LIJA MADERA

(100 mm.) JFN

Soporte **papel**. Óptimo para la lijadura y acabado en seco de madera, barnices y masillas.

3 mt.



REFERENCIA	GRANO	OFERTA
IM-12449542	40	3,50 €
IM-12449563	60	2,92 €
IM-12449584	80	
IM-12449591	150	

ROLLO LIJA UNIVERSAL

(115 mm.) KPF

Soporte **papel** al látex. Flexible como tela, se emplea en seco y húmedo. Ideal para alisar las superficies perfiladas bastas o tratadas. Barnices, madera y materias plásticas.

5 mt.



REFERENCIA	GRANO	OFERTA
IM-217060	60	4,20 €
IM-217100	100	3,26 €
IM-217150	150	
IM-217240	240	

CINTAS BIMETÁLICAS

Hojas bimetálicas al cobalto M42 para elevadas prestaciones de corte de metales. Ideales para corte en seco. Gran resistencia y productividad, tanto en materiales macizos, como en perfilados. Todas disponibles en varios dentados:

- **Mayor número de dientes:** válidas para tubo grueso o materiales muy duros.
- **Dentado intermedio:** universales.
- **Dentado mínimo:** Para tubo fino o materiales blandos.
- **(*) Máximo dentado:** Fabricación especial.



	REFERENCIA	DESCRIPCIÓN	VÁLIDAS PARA MOD. CON NG SYSTEM	OFERTA BLISTER 2 UDS.
1440	FMCINT6NG120	1440x13x0.65 Z/1" 6	NG 120 / ABS NG120	47,00 €
	FMCINT812NG120	1440x13x0.65 Z/1" 8/12	NG 120 / ABS NG120	
	FMCINT14NG120	1440x13x0.65 Z/1" 14	NG 120 / ABS NG120	
	FMCINT18NG120	1440x13x0.65 Z/1" 18 (*)	NG 120 / ABS NG120	
1750	FMCINT6NG160	1735x13x0.9 Z/1" 6	NG-160 / ABS NG160	53,00 €
	FMCINT610NG160	1735x13x0.9 Z/1" 6/10	NG-160 / ABS NG160	
	FMCINT14NG160	1735x13x0.9 Z/1" 14	NG-160 / ABS NG160	

	REFERENCIA	DESCRIPCIÓN	VÁLIDAS PARA	OFERTA CAJA 2 UDS.
1330	FMCINT6780	1335x13x0.65 Z/1" 6	782 / 783 / 780 P / mod. XL y ABS 105	46,00 €
	FMCINT812780	1335x13x0.65 Z/1" 8/12	782 / 783 / 780 P / mod. XL y ABS 105	
	FMCINT14780	1335x13x0.65 Z/1" 14	782 / 783 / 780 P / mod. XL y ABS 105	
	FMCINT18780	1335x13x0.65 Z/1" 18 (*)	782 / 783 / 780 P / mod. XL y ABS 105	
1440	FMCINT812784	1440x13x0.65 Z/1" 8/12	784 XL	47,00 €
	FMCINT14784	1440x13x0.65 Z/1" 8/14	784 XL	
1750	FMCINT461750	1735x20x0.9 Z4/6	1750 XL - 1750 XLABS	55,00 €
	FMCINT8121750	1735x20x0.9 Z8/12	1750 XL - 1750 XLABS	
	FMCINT6101750	1735x20x0.9 Z6/10	1750 XL - 1750 XLABS	
	FMCINT141750	1735x20x0.9 Z14	1750 XL - 1750 XLABS	
1750	FMCINT6785	1735x13x0.9 Z/1" 6	785 P / 785XL	52,00 €
	FMCINT610785	1735x13x0.9 Z/1" 6/10	785 P / 785XL	
	FMCINT14785	1735x13x0.9 Z/1" 14	785 P / 785XL	
2200	FMCINT46792	2140x19x0.9 Z/1" 4/6	2200XL / 2200DAXL	65,00 €
	FMCINT610792	2140x19x0.9 Z/1" 6/10	2200XL / 2200DAXL	
	FMCINT14792	2140x19x0.9 Z/1" 14	2200XL / 2200DAXL	
2500	FMCINT610251	2480x27x0.9 6/10	N250DAXL Y N251DAXL	76,00 €
	FMCINT46251	2480x27x0.9 4/6	N250DAXL Y N251DAXL	
	FMCINT812251	2480x27x0.9 8/12	N250DAXL Y N251DAXL	
	FMCINT14251	2480x27x0.9 10/14	N250DAXL Y N251DAXL	
2750	FMCINT610310	2750x27x0.9 6/10	N310DA/DG	82,00 €
	FMCINT10/14310	2750x27x0.9 10/14	N310DA/DG	

DISCOS DE WIDIA / ANILLOS DE REDUCCIÓN

PARA MÁQUINAS
ESTÁTICAS



CÓDIGO	∅ D=mm.	Grueso B=mm.	Eje D=mm.	Z	OFERTA
DM25430Z42	254	3,2	30	42	25,00 €
DM25430Z60	254	3,2	30	60	27,00 €
DM25030Z42	250	3,2	30	42	25,00 €
DM30030Z48	300	3,2	30	48	29,00 €
SC-7091201705	305	3,2	30	24	49,00 €
SC-7091200707	305	3,2	30	60	49,00 €
DM30530Z96	305	3,2	30	96	50,00 €
DM35030Z54	350	3,5	30	54	55,00 €
DM35030Z84	350	3,5	30	84	59,00 €

PARA MÁQUINAS
PORTÁTILES



CÓDIGO	∅ D=mm.	Grueso B=mm.	Eje D=mm.	Z	CON ANILLO DE REDUCCIÓN	OFERTA
SC-3901802704	160	2,4	30	24		15,00 €
SC-3901802705	160	2,2	30	48		18,00 €
DM20030Z30PRT	200	2,8	30	30	30/25, 30/20, 30/18	20,00 €
SC-7901800601	210	2,8	30	30	-	18,00 €
SC-7901800602	210	2,8	30	72	-	28,00 €
SC-7901200705	216	2,8	30	48	-	29,00 €

ESPECIAL MADERA
MADERA PLASTIFICADA

Discos silenciosos



CÓDIGO	∅ D=mm.	Grueso B=mm.	Eje D=mm.	Z	OFERTA
DM25030Z60	250	3,2	30	60	51,00 €
DM25030Z80	250	3,2	30	80	69,00 €
DM30030Z72	300	3,2	30	72	69,00 €
DM30030Z96	300	3,2	30	96	98,08 €
DM30530Z72	300	3,2	30	72	72,00 €

ESPECIAL ALUMINIO

Discos silenciosos



CÓDIGO	∅ D=mm.	Grueso B=mm.	Eje D=mm.	Z	OFERTA
DA30030Z96	300	3,2	30	96	108,34 €

PARA ALUMINIO

CÓDIGO	∅ D=mm.	Grueso B=mm.	Eje D=mm.	Z	OFERTA
DA21030Z48	210	3,0	30	48	19,00 €
DA25030Z80	250	3,2	32	80 (*)	35,00 €
DA35030Z108	350	3,0	30	108	89,00 €
DA40030Z96	400	3.6/3.0	30	96	104,94 €
DA42030Z120	420	3.8/3.2	30	120	149,00 €
DA50030Z120	500	4.0/3.4	30	120	199,00 €
DA53030Z120	530	4.0/3.4	30	120	219,00 €



PARA DESBROZADORAS

CÓDIGO	∅ D=mm.	Grueso B=mm.	Eje D=mm.	Z	OFERTA
DB25020Z20	250	2,8	20	20	21,00 €

MADERA CON CLAVOS

CÓDIGO	∅ D=mm.	Grueso B=mm.	Eje D=mm.	Z	OFERTA
DC31530Z20	315	3,2	30	20	21,20 €

ANILLOS DE REDUCCIÓN

Juego de tres uds.

REFERENCIA	REDUCCIÓN	OFERTA
SUCA151825	30/16 • 30/20 • 30/22	8,00 €
SUCA162022	30/15 • 30/18 • 30/25	8,00 €



DISCOS DE LAMINAS Y FRESAS

DISCOS DE LÁMINAS PARA HIERRO

REFERENCIA	GRANO	OFERTA
DL11540H	40	1,72 €
DL11560H	60	1,72 €
DL11580H	80	1,72 €
DL115100H	100	1,72 €
DL115120H	120	1,72 €
DL12540H	40	2,06 €
DL12560H	60	2,06 €
DL12580H	80	2,06 €
DL125100H	100	2,06 €
DL125120H	120	2,06 €
DL18040H	40	5,72 €
DL18060H	60	5,72 €
DL18080H	80	5,72 €
DL180100H	100	5,72 €
DL180120H	120	5,72 €



DISCOS DE LÁMINAS PARA INOXIDABLE

REFERENCIA	GRANO	OFERTA
DL11540INOX	40	1,83 €
DL11560INOX	60	1,83 €
DL11580INOX	80	1,83 €
DL115100INOX	100	1,83 €
DL115120INOX	120	1,83 €
DL12580INOX	80	2,18 €
DL125100INOX	100	2,18 €
DL125120INOX	120	2,18 €
DL18040INOX	40	5,72 €
DL18060INOX	60	5,72 €
DL18080INOX	80	5,72 €
DL180100INOX	100	5,72 €
DL180120INOX	120	5,72 €



Embalaje de 20 unidades. (ø 115 - 125) 10 unidades. (ø 180)

Embalaje de 20 unidades. (ø 115 - 125) 10 unidades. (ø 180)

FRESAS METAL DURO PARA MADERA

FRKIT6 (MANGO 8)

Composición:

- Fresa cóncava R 6.3 mm.
- Fresa recta 6 mm.
- Fresa moldura R 6.3 mm.
- Fresa enrasadora 12.7 mm.
- Fresa recta 12 mm.
- Fresa cola milano 12.7 mm.

Caja 6 unidades

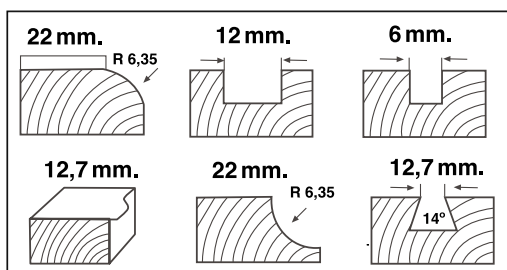

19,95 €

FRESAS PARA PERNIOS

REFERENCIA	MEDIDAS		OFERTA
	Ø	MANGO	
FRH 12	12	6	26,86 €
FRH 13	13	6	26,86 €
FRH 14	14	6	26,86 €
FRH 15	15	6	26,86 €



FRESAS DE DISCO

REFERENCIA	MEDIDAS		OFERTA
	A	B	
FR 65	40	1,5	12,85 €
FR 66	40	2,0	12,79 €
FR 67	40	2,5	12,79 €
FR 68	40	3,0	12,79 €
FR 69	40	4,0	12,79 €
FR 70	40	5,0	12,79 €
FR 71	40	6,0	15,27 €

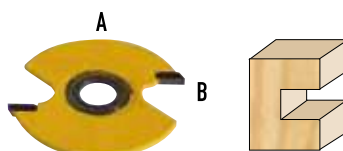

MANGO PARA FRESAS DE DISCO

REFERENCIA	EJE	OFERTA
MANGO 6		
FR 72	8	10,25 €
FR72/6	6	9,67 €
MANGO 8		
FR 73	8	10,32 €
FR73/6	6	9,74 €



FRESAS

FRESAS INDIVIDUALES

REFERENCIA		MEDIDAS				OFERTA
MANGO 6	MANGO 8	A	B	D+B	R	
FR 40-6	FR 40-8	22,2	12,7	49	4,8	25,59 €
FR 41-6	FR 41-8	25,4	12,7	49	6,3	16,90 €
FR 42-6	FR 42-8	28,6	12,7	49	7,9	18,87 €
FR 43-6	FR 43-8	31,8	15,9	52	9,5	20,39 €
FR 44-6	FR 44-8	38,1	19,1	55	12,7	22,91 €



REFERENCIA		MEDIDAS				OFERTA
MANGO 6	MANGO 8	A	B	D+B	R	
FR 1-6	FR 1-8	3	11	51		5,11 €
FR 2-6	FR 2-8	4	11	51		5,62 €
FR 3-6	FR 3-8	5	11	51		5,62 €
FR 4-6	FR 4-8	6	19	57		7,10 €
FR 5-6	FR 5-8	6	25	61		7,10 €
FR 7-6	FR 7-8	8	19	57		7,10 €
FR 8-6	FR 8-8	8	25	63		7,10 €
FR 9-6	FR 9-8	10	19	51		7,68 €
FR 10-6	FR 10-8	10	32	63		7,10 €
FR 11-6	FR 11-8	12	19	54		7,68 €
FR 12-6	FR 12-8	12	32	63		7,68 €
FR 13-6	FR 13-8	14	19	52		10,61 €
FR 14-6	FR 14-8	16	25	57		7,68 €
FR 15-6	FR 15-8	18	19	52		10,14 €
FR 16-6	FR 16-8	20	19	52		10,14 €
FR 22-6	FR 22-8	22	19	52		10,14 €
FR 25-6	FR 25-8	25	19	52		12,51 €
FR 76-6	FR 76-8	15	19	52		7,68 €

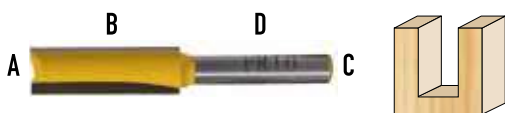

REFERENCIA		MEDIDAS				OFERTA
MANGO 6	MANGO 8	A	B	D+B	E	
FR 51-6	FR 51-8	31,8	12,7	50	45°	32,69 €

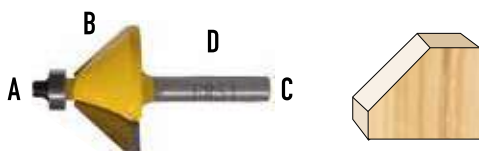

REFERENCIA		MEDIDAS				OFERTA
MANGO 6	MANGO 8	A	B	D+B	E	
FR 34-6	FR 34-8	12,7	12,7	44	14°	16,37 €



REFERENCIA		MEDIDAS				OFERTA
MANGO 6	MANGO 8	A	B	D+B	R	
FR 47-6	FR 47-8	22,2	14,3	52	6,3	29,08 €
FR 48-6	FR 48-8	25,4	14,3	52	7,9	22,35 €
FR 49-6	FR 49-8	28,6	14,3	52	9,5	24,80 €
FR 50-6	FR 50-8	34,9	19,1	57	12,7	27,88 €

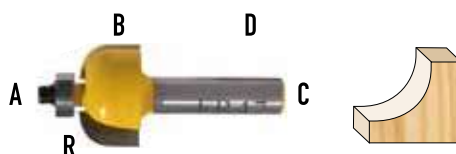

REFERENCIA		MEDIDAS			OFERTA
MANGO 6	MANGO 8	A	B	D+B	
FR 31-6	FR 31-8	12,7	12,7	44(60°)	19,79 €
FR 32-6	FR 32-8	12,7	12,7	44(90°)	14,24 €
FR 33-6	FR 33-8	19,1	15,9	44(90°)	12,62 €



REFERENCIA		MEDIDAS				OFERTA
MANGO 6	MANGO 8	A	B	D+B	R	
FR 35-6	FR 35-8	22,2	12,7	49	4,8	6,66 €
FR 36-6	FR 36-8	25,4	12,7	49	6,3	16,90 €
FR 37-6	FR 37-8	28,6	12,7	49	7,9	18,87 €
FR 38-6	FR 38-8	31,8	15,9	52	9,5	19,79 €
FR 39-6	FR 39-8	38,1	19,1	55	12,7	21,72 €

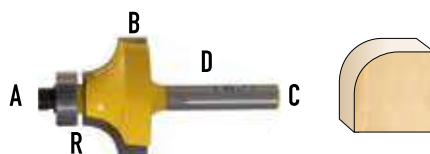

FRESAS

REFERENCIA		MEDIDAS					OFERTA
MANGO 6	MANGO 8	A	B	D+B	R		
FR 26-6	FR 26-8	6,3	4,8	44	3,2	14,05 €	
FR 27-6	FR 27-8	9,5	6,3	38	4,8	9,47 €	
FR 28-6	FR 28-8	12,7	7,9	38	6,3	11,39 €	
FR 29-6	FR 29-8	15,9	9,5	38	7,9	13,19 €	
FR 30-6	FR 30-8	19,1	12,7	38	9,5	17,82 €	

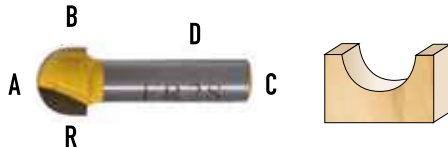

REFERENCIA		MEDIDAS					OFERTA
MANGO 6	MANGO 8	A	B	D+B	R		
FR 45-6	FR 45-8	25,4	15,9	52	4,0	25,59 €	
FR 46-6	FR 46-8	34,9	22,2	57	6,3	26,84 €	

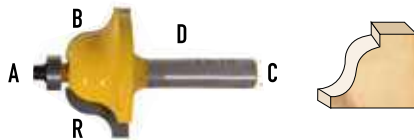

REFERENCIA		MEDIDAS						OFERTA
MANGO 6	MANGO 8	A	B	D+B	R1	R2		
FR 53-6	FR 53-8	25,4	15,9	52	4,0	4,0	23,06 €	
FR 54-6	FR 54-8	34,9	22,2	57	6,3	6,3	37,84 €	
FR 88-6	FR 88-8	37,1	12,7	52	4,7	1,6	37,84 €	
FR 89-6	FR 89-8	38,1	15,9	53	6,0	3,6	45,50 €	

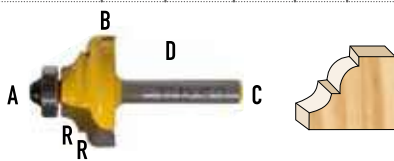

REFERENCIA		MEDIDAS					OFERTA
MANGO 6	MANGO 8	A	B	D+B	R		
FR 83-6	-	22,2	13,5	54	3,2	12,37 €	
FR 84-6	FR 84-8	28,2	16,0	57	4,8	16,55 €	
FR 85-6	FR 85-8	31,8	19,0	60	7,0	32,69 €	

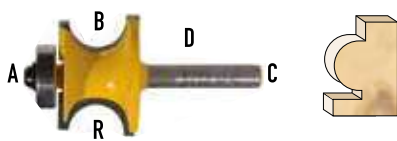

REFERENCIA		MEDIDAS					OFERTA
MANGO 8	A	B	D+B	R	R		
FR 62-8	19	12	54	45°	6,3	63,43 €	



REFERENCIA		MEDIDAS					OFERTA
MANGO 8	A	B	D+B	R	R		
FR 63-6	FR 63-8	24	12	55	25°	86,54 €	



REFERENCIA		MEDIDAS					OFERTA
MANGO 6	MANGO 8	A	B	D+B	R		
FR 57-6	FR 57-8	9,5	7,9	50	3,2	38,59 €	

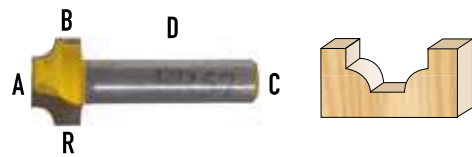

REFERENCIA		MEDIDAS				OFERTA
MANGO 6	MANGO 8	A	B	D+B		
FR 58-6	FR 58-8	12,7	25,4	63	10,95 €	
FR 59-6	FR 59-8	16,0	15,9	50	9,09 €	



REFERENCIA		MEDIDAS				OFERTA
MANGO 6	MANGO 8	A	B	D+B		
FR 64-6	FR 64-8	6,3	19,1	63	10,14 €	



REFERENCIA		MEDIDAS						OFERTA
MANGO 6	MANGO 8	A	B	D+B	R1	R2		
FR 55-6	FR 55-8	34,9	13,5	52	4,8	3,6	37,84 €	

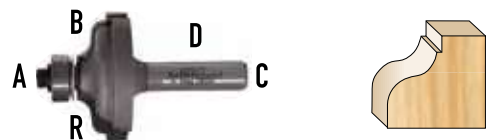

REFERENCIA		MEDIDAS						OFERTA
MANGO 6	MANGO 8	A	B	D+B	R1	R2		
FR 93-6	FR 93-8	19,1	12,7	54	3,7	4,0	23,23 €	

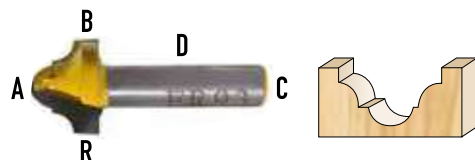

CORONAS MULTISIERRAS/CUCHILLAS/ CORTACÍRCULOS

XWY-02K006

Ø 60-67-74-81-95 mm.

Corona de alta potencia de corte. Hojas de acero al tungsteno. Con broca de centrado de 10 mm. Vástago hexagonal y cuerpo metálico. Profundidad de corte 33 mm.

Usos:

- Madera.
- Yeso encartonado.
- Planchas de construcción.
- Metales no féreos.



8€

XWY-02K005

Ø 26-35-38-45-50-56-63 mm.

Corona de alta potencia de corte. Hojas de acero al tungsteno. Con broca de centrado de 8 mm. Vástago hexagonal y cuerpo metálico. Profundidad de corte 18 mm.

Usos:

- Madera.
- Yeso encartonado.
- Planchas de construcción.
- Metales no féreos.



4€

CUCHILLAS REVERSIBLES PARA CEPILLOS ELÉCTRICOS PORTÁTILES



Válidas para mod.: RYOBI, AEG, BLACK & DECKER, BOSCH, DEWALT, HITACHI, MAKITA, METABO, SKILL, VIRUTEX.

REFERENCIA	MEDIDAS	OFERTA
CU-REBLI82	Blister 2 uds. 82 mm.	5,00 €
CU-RECAJA10/78B	Caja 10 uds. 78 mm.	20,00 €
CU-RECAJA10/82B	Caja 10 uds. 82x55x1,1 mm.	20,00 €

72



XWY-06K003

Corte de 30 a 250 mm.

Cortacírculos con cuchillas ajustables, para cortes en techos, paredes y suelos

Usos:

- Madera laminada.
- Madera contrachapada.
- Yeso laminado.
- Planchas acrílicas.



10,50€

XWY-06K010

Cortacírculos regulable

- Con cuchillas ajustables.
- Contra-chapado, plástico, pladur, escayola, yeso...
- Con pantalla protectora.



Especial para techos
Corte regulable de 40 a 250 mm.

Cuchilla corta

Ref. XWY-06K010-1
P.V.P.: 4,00 €

Cuchilla Widia

Ref. XWY-06K010-2
P.V.P.: 4,00 €

Cuchilla larga

Ref. XWY-06K010/1
P.V.P.: 4,50 €

79,95€

CEPILLERÍA DE ALAMBRE

CEPILLOS CIRCULARES DE TELA DE ALGODÓN

Para pulir el metal usando taladros y esmeriladoras.

REF.	Ø	VÁSTAGO	EJE	OFERTA
ITBSP80	80	6 X 27	/	7,25 €
ITBSP150	150	/	16 - 20	11,16 €
ITSP200	200	/	20	19,03 €



CEPILLOS DE TAZA DE ACERO LATONADO

Eje M-14

Para cepillado de grandes superficies en astilleros, calderería, construcción, etc. con amoladoras angulares.

REF.	Ø	Ø HILO	OFERTA
ITT80BOX	75	0,30	8,83 €
ITT100	100	0,30	11,04 €
ITT120	120	0,30	15,23 €
ITT80Inox	75	0,30	16,31 €
ITT100Inox	100	0,30	26,90 €



CEPILLOS DE TAZA TRENZADOS DE ACERO

Eje M-14

Para rebabas, satinado y pulido de grandes superficies con amoladoras angulares.

REF.	Ø	TRENZA	OFERTA
ITTU71	70	18	16,03 €
ITTU85	85	22	28,54 €
ITTU111	105	26	35,28 €
ITTU131	120	32	43,61 €



CEPILLOS CÓNICOS DE ACERO

Eje M-14

Para limpiezas de soldaduras y superficies irregulares en taladros y amoladoras angulares.

REFERENCIA	Ø	Ø HILO	TRENZA	OFERTA
ITC090BOX (*)	95	0,30	18	7,87 €
ITC0120BOX	120	0,30	22	17,73 €
ITCZ95BOX	95	0,30	26	14,04 €
ITCZ120BOX	120	0,30	32	16,50 €
ITC090INOX	95	0,30	32	15,40 €



(*) Acero latonado.

CEPILLOS CIRCULARES DE ACERO LATONADO

Ø Hilo 0,30

Para eliminación de óxidos, rebabas, pinturas, limpieza de piezas de fundición, cardado de pieles y cuero. Para usar con esmeriladoras.

REF.	Ø	EJE	ESPESOR	OFERTA
IT3102	100	16	15	16,93 €
IT3122	125	16	17	17,10 €
IT4152	150	16	20	17,90 €
IT4203	200	20	29	29,28 €
IT6253	250	35	30	57,14 €



CEPILLOS

Limpieza de todo tipo de adherencias, pinturas y óxidos.

REF.	CALIDAD	Ø HILO	OFERTA
CE-SPIDBOX	Acero latonado	0.30	2,12 €
CE-SPIDBOXINOX	Acero Inox.	0.15	2,66 €
ITSPIDPVC	PVC	0.30	5,00 €



CEPILLOS DE ACERO PARA TALADROS

Eliminación de óxidos, pinturas y adherencias. Preparación de superficies para la pintura. Pulido de piezas metálicas.

REF.	Ø	EJE	Ø HILO	ESPESOR	OFERTA
ITBG50	50	6 X 25	0,30	9	2,66 €
ITBG75	75	6 X 25	0,30	9	4,13 €
ITBG100	100	6 X 25	0,30	9	4,97 €
ITBTE50	50	6 X 30	0,30	/	3,52 €
ITBTE75	75	6 X 30	0,30	/	4,49 €
ITBGG73	70	6 X 25	0,30	12	13,47 €
ITBGG103	100	6 X 25	0,30	16	17,75 €
ITBP25	25	6 X 21	0,30	25	5,25 €
ITP20INOX15	22	6 X 21	0,15	22	11,26 €
ITP20INOX	22	6 X 21	0,30	22	9,25 €
ITBGZ71	70	6 X 25	0,50	15	17,75 €



BP



BTE



BG



BGG

CEPILLO PARA DESBROZADORA

Para desbrozadoras de más de 1,5 HP. Medida: 200x25,4x38 mm./z 36. 10.000 r.p.m. max. Acero 0,50 mm.

REFERENCIA	OFERTA
ITCZ200	57,81 €



MIRA EL VIDEO



CUBOS CAUCHO

F-88001T

Cubo italiano 10 Lt.
32x32x18
1,56 kg.



7,86€

F-880012

Espuerta 11 Lt.
40x29x15 cm.
11 kg.



7,75€

F-8812PICO

Cubo de obra con pico. 12 Lt.
32x33x31 cm.
1,8 Kg.



9,99€

F-880011

Gaveta. 12 Lt.
42x53x15 cm.
2,16 kg.



12,87€

F-880028

Espuerta. 20 Lt.
45x55x16,5 cm.
2,88 kg.



13,99€

F-880030

Carbonera. 30 Lt.
43x50x34 cm.
2,91 kg.



13,99€

74

F-880015

Gaveta 15 Lt.
54,6x43,6x17 cm.
2,64 kg.



13,79€



CUBOS PLÁSTICO

F-880003

Cubeta 3 Lt.
32x22x6,5 cm.
0,18 kg.



1,83€

CU-CALDERETA11

Caldereta 10 Lt.
Alto: 13 cm.
Boca: 32 cm.



2,59€

CU-CAPAZO

Capazo 42 Lt.
Alto: 33 cm.
Boca: 44 cm.



2,99€

CU-CAPAZO55

Capazo 55 Lt.
Alto:33 cm. Boca: 53 cm.



4,25€

FM-TR076

Disco Ø210 mm. 1200 W.
Motor universal

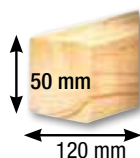

185 €

FM-TR230

Disco Ø255 mm. 1600 W.
Motor universal

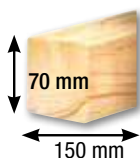

259 €

FM-TR235

Disco Ø250 mm. 1800 W.
Motor universal

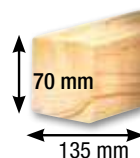

309 €

FM-TR240

Disco Ø254 mm. 1450 W.
Motor universal

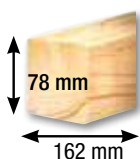

369 €



FM-TR090

Disco Ø305 mm. 2000 W.
Motor universal

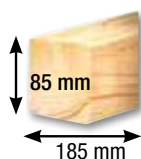

439 €

75

FM-TR1021

Disco Ø210 mm. 1500 W.
Motor universal

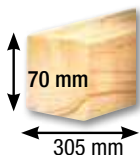

289 €

FM-TR1025DB

Disco Ø255 mm. 2000 W.
Motor universal. Doble inclinación

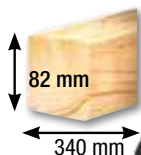

399 €

FM-TR1030DB

Disco Ø305 mm. 2000 W.
Motor universal. Doble inclinación

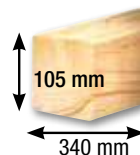

499 €

FM-999EVO

Disco Ø305 mm. 1.700 W.
Motor universal

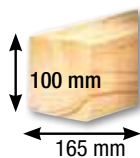

999€

FM-1050/3D

Disco Ø305 mm.
1.800 W.
Motor universal
Telescópica

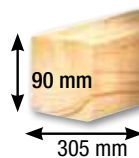

899€

FM28-182

250 W.-230V.
Cinta:
1.400x6x0,35-Z6

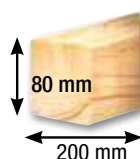

199€

FM28-186

420 W.-230V.
Cinta:
1.790x10x0,35-Z6



334€

FM28-191

750 W.-230V.
Cinta:
2.240x12,5x0,5



669€

FM28-194

1100 W.-230V.
Cinta:
2.560x10x0,5

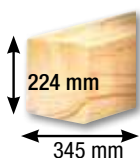

1,399€

FM28-195

2200 W.-230V.
Cinta:
3.607x25x0,6-Z3

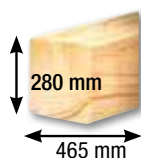

**CONSULTAR
PRECIO**

FM-PF250

Máquina combinada. 1500 W.
Ancho cepillado: 254 mm.
Alto regreuso de: 5 a 120 mm.
Cuchillas:
261x16,5 mm.
Ref.: F22-573
P.V.P.: 49 €



519€

FM-CYCLONE

Cepilladora regruesadora
1.500 W.



Cuchillas 210x20x1,6 mm.
Ref.: FM3280010 P.V.P.: 45 €

599 €

FM-330SMARTY

Banco plegable.

Carga 100 Kg. max.

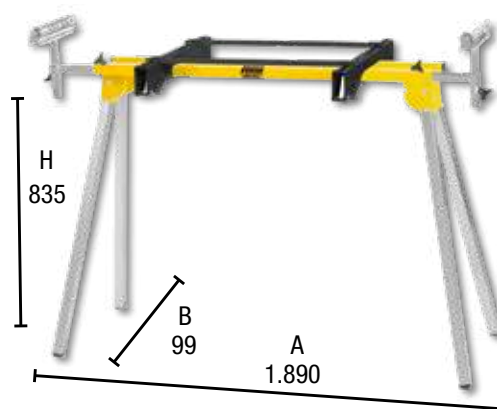

129 €

BD31-462

Lijadora combinada. 370 W.
Ø Disco de lija 150 mm.
autoadhesivo.
Banda de lija 100x914mm.



**CONSULTAR
PRECIO**

SH23-730

Afiladora 150 W.
Muela 200x40x12 mm.
Disco 200x30x12



**CONSULTAR
PRECIO**

SS40-562

Sierra para marquetería
125 W.
Hoja de sierra
127 mm.

LED



**CONSULTAR
PRECIO**

77

FM-IB500

Encoladora de cantos. 2.000 W.
Flujo de calor 18 - 30 m³/h
350° - 500° °C

2 velocidades
Guía ajustable



599 €

CS20-140

Tronzadora metal
Disco Ø355 mm.
2.000 W.
3.000 r.p.m.

Metal



**CONSULTAR
PRECIO**

Aspiradores versátiles y manejables para operaciones de aspiración de serrín. Adaptación para el acoplamiento con máquinas de carpintería. Silenciosos motores de inducción potentes y fiables con protección térmica de seguridad. Filtración 35 microns. Ventilador de aspiración de aluminio. Bases con ruedas giratorias para el transporte. Se suministran en Kit de montaje.

FM-DC350PLUS

900 W.

950 m³/h

Ø boquilla para tubo aspiración: 100x1

Presión: 175 mm. H₂O

- Tubo flexible longitud 2 m.
- Boquilla para pavimentos
- Bolsa de recogida de polvo nylon
- Bolsa filtrante en hebrado (5µm) para virutas

Monofásico



429€

FM-DC351PLUS

1.500 W.

2.700 m³/h

Ø boquilla para tubo aspiración: 100x2

Presión: 196 mm. H₂O

- Tubo flexible longitud 2 m.
- Bolsa de recogida de polvo nylon
- Bolsa filtrante en hebrado (5µm) para virutas

Monofásico



629€

78

FM-DC352PLUS

1.500 W.

2.700 m³/h

Ø boquilla para tubo aspiración: 100x2

Presión: 196 mm. H₂O

- Tubo flexible longitud 2 m.
- Bolsa de recogida de polvo nylon
- Bolsa filtrante en hebrado (5µm) para virutas

Trifásico



629€

FM-DC355PLUS

2.200 W.

3.900 m³/h

Ø boquilla para tubo aspiración: 100x3

Presión: 196 mm. H₂O

- Tubo flexible longitud 2 m.
- Bolsa de recogida de polvo nylon
- Bolsa filtrante en hebrado (5µm) para virutas

Trifásico



849€

FM-780XL
MEDIDA CINTA
(mm/Ø):
1.335x13x0,65
850 W.
2 velocidades



429€

CAPACIDAD DE CORTE			
0°	105x93 mm.	105 mm.	102x102 mm.
45°	70x60 mm.	72 mm.	68x68 mm.

FM-784XL
MEDIDA CINTA
(mm/Ø):
1.440x13x0,65
1.200 W.
Regulación electrónica
"Constant speed"



759€

CAPACIDAD DE CORTE			
0°	120x115 mm.	120 mm.	119x119 mm.
45°	85x70 mm.	85 mm.	80x80 mm.

FM-785XL
MEDIDA CINTA
(mm/Ø):
1.735x13x0,9
1.600 W.
2 velocidades



1.199€

CAPACIDAD DE CORTE			
0°	205x150 mm.	152 mm.	150x150 mm.
45°	105x95 mm.	106 mm.	102x102 mm.

FM-ABS105
MEDIDA CINTA
(mm/Ø):
1.335x13x0,65
950 W.
2 velocidades

Bajada automática



771€

CAPACIDAD DE CORTE			
0°	100x85 mm.	105 mm.	95x95 mm.
45°	65x60 mm.	65 mm.	65x65 mm.

FM-ABSNG120
MEDIDA CINTA
(mm/Ø):
1.440x13x0,65
1.300 W.
Regulación electrónica
"Constant speed"

Bajada automática

MÁS VELOCIDAD
60%
NG
REGENERATION



1.166€

CAPACIDAD DE CORTE			
0°	120x102 mm.	120 mm.	112x112 mm.
45°	78x78 mm.	80 mm.	78x78 mm.
60°	50x43 mm.	50 mm.	48x48 mm.

FM-ABSNG160
MEDIDA CINTA
(mm/Ø):
1.735x13x0,9
2.000 W.
Regulación electrónica
"Constant speed"

Bajada automática

MÁS VELOCIDAD
60%
NG
REGENERATION



1.775€

CAPACIDAD DE CORTE			
0°	160x140 mm.	150 mm.	150x150 mm.
45°	120x120 mm.	100 mm.	100x100 mm.

FM-2200XL

MEDIDA
CINTA (mm/Ø):
2.140x19x0,9
2.000 W.
Regulación
electrónica
"Constant speed"



Monofásica

2.100€

CAPACIDAD DE CORTE			
0°	200x75 mm. 190x135 mm.	175 mm.	175x175 mm.
45°	150x110 mm.	110 mm.	110x110 mm.
60°	100x70 mm.	75 mm.	75x75 mm.

FM-2200DAXL

MEDIDA
CINTA (mm/Ø):
2.140x19x0,9
2.000 W.
Regulación
electrónica
"Constant speed"



Sistema
hidráulico
de control
de bajada
automática
Monofásica

2.500€

CAPACIDAD DE CORTE			
0°	200x75 mm. 190x135 mm.	175 mm.	175x175 mm.
45°	150x110 mm.	110 mm.	110x110 mm.
60°	100x70 mm.	75 mm.	75x75 mm.

FM-N250DAXL

MEDIDA
CINTA (mm/Ø):
2.480x27x0,9
1.100 W.



Sistema
hidráulico
de control
de bajada
automática
Monofásica

2.999€

CAPACIDAD DE CORTE			
0°	245x160 mm. 250x110 mm.	225 mm.	185x185 mm.
45°	135x185 mm. 145x150 mm.	150 mm.	145x145 mm.
60°	63x107 mm. 69x90 mm.	70 mm.	70x70 mm.

FM-N251DAXL

MEDIDA
CINTA (mm/Ø):
2.480x27x0,9
750/1100 W.
2 velocidades



Sistema
hidráulico
de control
de bajada
automática
Trifásica

2.999€

CAPACIDAD DE CORTE			
0°	245x160 mm. 250x110 mm.	225 mm.	185x185 mm.
45°	135x185 mm. 145x150 mm.	150 mm.	145x145 mm.
60°	63x107 mm. 69x90 mm.	70 mm.	70x70 mm.

FM-N310DA/DG

MEDIDA
CINTA (mm/Ø):
2.750x27x0,9
1.000/1500 W.
2 velocidades

CAPACIDAD DE CORTE			
0°	320x200 mm.	255 mm.	195 mm.
45° IZDA.	210x80 mm.	205 mm.	195 mm.
60°	120x135 mm.	125 mm.	125 mm.
45° DCHA.	170x190 mm.	205 mm.	175 mm.

4.999€



Sistema
hidráulico
de control
de bajada
automática
Trifásica

PROFESIONALES, ECOLÓGICAS E INDUSTRIALES

FM-404

Esmeriladora/pulidora
Motor 370 W.
2.800 r.p.m. Ø Muela 150x20x16 mm.

Doble muela



339 €

FM-405

Esmeriladora/pulidora
Motor 500 W. 230 V.
2.800 r.p.m. Ø Muela 200x20x16 mm.

Doble muela



399 €

FM-424

Esmeriladora/pulidora
Motor 370 W. 230 V.
Ø Muela 150x20x16 mm.
Ø Cepillo 150x20x16 mm.

Muela/Cepillo



399 €

FM-425

Esmeriladora/pulidora
Motor 500 W. 230 V.
Ø Muela:
200x20x16 mm.
Ø Cepillo:
150x20x16 mm.

Muela/Cepillo



479 €

ESMERILADORAS INDUSTRIALES

REF.	POTENCIA	MUELA	RPM	OFERTA
FM-240M	450 W. - 230 V.	150x20x16	2800	459 €
FM-241M	450 W. - 380 V.	150x20x16	2800	459 €
FM-242M	750 W. - 230 V.	200x25x20	2800	639 €
FM-243M	850 W. - 380 V.	200x25x20	2800	639 €
FM-143MEVO	1100 W. - 380 V.	200x30x20	2800	1.069 €
FM-145MEVO	1500 W. - 230 V.	250x35x25	1400	1.369 €
FM-146M	2200 W. - 230 V.	300x40x20	1400	2.900 €

Doble muela



ESMERILADORAS INDUSTRIALES COMBINADAS

Muela/Cepillo

REF.	POTENCIA	MUELA	CEPILLO	OFERTA
FM-244M	450 W. - 230 V.	150x25x16	150x25x16	575 €
FM-245M	450 W. - 380 V.	150x25x16	150x25x16	575 €
FM-246M	750 W. - 230 V.	200x25x20	200x25x16	720 €
FM-247M	850 W. - 380 V.	200x25x20	200x25x16	720 €
FM-163MEVO	1100 W. - 380 V.	200x40x20	200x30x20	1.200 €
FM-165MEVO	1500 W. - 380 V.	250x40x25	250x40x20	1.500 €
FM-166M	2200 W. - 380 V.	300x40x20	300x60x25	2.999 €



PULIDORAS INDUSTRIALES

REF.	POTENCIA	CEPILLO	RPM	OFERTA
FM-213	750 W. - 230 V.	200x25x16	2800	899 €
FM-214	850 W. - 380 V.	200x25x16	2800	939 €
FM-209EVO	1100 W. - 380 V.	250x40x20	2800	1.400 €
FM-211	2200 W. - 380 V.	300x60x25	2800	3.200 €



ESMERILADORAS ECOLÓGICAS DE DOBLE MUELA

Doble muela

REF.	POTENCIA	MUELA	RPM	OFERTA
FM-191M	450 W. - 380 V.	150x20x16	2800	1.600 €
FM-192M	850 W. - 380 V.	200x25x20	2800	1.800 €
FM-193MEVO	1100 W. - 380 V.	200x30x20	2800	2.200 €
FM-194MEVO	1500 W. - 380 V.	200x35x25	1400	2.400 €
FM-195M	2200 W. - 380 V.	300x40x30	1400	3.999 €



ESMERILADORAS COMBINADAS ECOLÓGICAS

Muela/Cepillo

REF.	POTENCIA	CEPILLO	RPM	OFERTA
FM-196M	450 W. - 380 V.	150x20x16	2800	1.800 €
FM-197M	850 W. - 380 V.	200x25x20	2800	1.900 €
FM-198MEVO	1100 W. - 380 V.	200x30x20	2800	2.300 €
FM-199MEVO	1500 W. - 380 V.	250x35x25	2800	2.600 €
FM-200M	2200 W. - 380 V.	300x40x30		4.300 €



PROFESIONALES, ECOLÓGICAS E INDUSTRIALES

PULIDORAS ECOLÓGICAS

REF.	POTENCIA	CEPILLO	OFERTA
FM-204	850 W. - 380 V.	200x25x16	2.100 €
FM-202EVO	1100 W. - 380 V.	250x40x20	2.500 €
FM-203	2200 W. - 380 V.	300x60x30	4.400 €



LIJADORAS DE BANDA

Industrial

REF.	POTENCIA	BANDA	RPM	OFERTA
FM-510	600 W. - 380 V.	100x220	2800	1.333 €
FM-511	550 W. - 230 V.	100x220	2800	1.333 €
FM-542B	1100 W. - 380 V.	120x1500	1400	1.750 €
FM-543B	750 W. - 230 V.	120x1500	1400	1.750 €
FM-504B	600 W. - 900 V.	120x1500	1400/2800	2.200 €
FM-507B	1350-1600 W. - 380 V.	150x1750	1400/2800	3.150 €



LIJADORAS DE BANDA/DISCO

Industrial

REF.	POTENCIA	BANDA mm	MT/SEC	Ø DISCO	OFERTA
FM-525B	1350-1600 W. - 380 V.	-	16	400	2.900 €
FM-539B	1350-1600 W. - 380 V.	150x1750	30	400	4.440 €



ESMERILADORAS/LIJADORAS DE BANDA

REF.	POTENCIA (W.)	BANDA	MUELA	RPM	OFERTA
FM-293N	750 W.-230 V.	100x1000	200x25x20	2800	999 €
FM-294N	850 W.-380 V.	100x1000	200x25x20	2800	999 €



ESMERILADORAS / LIJADORAS DE BANDA

Industrial

REF.	POTENCIA	BANDA	MUELA	RPM	OFERTA
FM-296EVO	1100 W. - 380 V.	50X2200	200X25X20	2800	2.400 €
FM-298EVO	1100 W. - 380 V.	50X2200	-	2800	3.300 €



LIJADORAS DE BANDA HORIZONTAL

Industrial

REF.	POTENCIA	BANDA	MT/SEC	SUP LIJA	OFERTA
FM-577	4000 W. - 380 V.	150X2000	15/30	460/180	1.800 €
FM-575	3000 W. - 380 V.	75X2000	30	460x75	1.200 €
FM-574	2200 W. - 230 V.	75X2000	30	460x75	1.200 €



W125

Depósito: 600 ml.
Tamaño de trabajo:
5m²/10 min
350 W.
WG-2409303

CLICK & PAINT



62€

W150

Depósito: 600 ml.
Tamaño de trabajo:
5m²/10 min
300 W.
WG-2359328

CLICK & PAINT



77€

W575 FLEXIO

Depósito: 1300 ml. +800 ml.
Tamaño de trabajo:
15m²/6 min
630 W.
WG-2397237

Depósito
adicional
WG-2361730

CLICK & PAINT



149€

W450PLUS

Depósito: 1300 ml.
Consumo 110 W.
Tamaño de trabajo:
15m²/10 min
460 W.
WG-2373631

Extensión
adicional
WG-2361756

CLICK & PAINT



134€

W690 FLEXIO

Depósito: 1800 ml
(pintura para pared)
800 ml (lacas y barnices)
630 W.
Para trabajos grandes:
15m²/6 min
Manguera 3,5 mt.
WG-2370368

CLICK & PAINT

Regulación de
caudal de aire
variable
Extensión
adicional
WG-2361756



157€

W950 FLEXIO

Depósito: 800 ml.
Tamaño de trabajo:
15m²/6 min
630 W.
WG-2361555

Depósito
adicional
WG-2361730

CLICK & PAINT



238€

W490

Depósito: 1300 ml
(pintura plástica)
800 ml (esmaltes)
350 W.
WG-2401082

CLICK & PAINT



59€

CP150M

Manguera: 7,5 mt.
Boquillas incluidas 311 - 517
300 W.
WG-2394312
No recomendada
para productos
con base
disolvente.

HEA HIGH EFFICIENCY AIRLESS

Lijadora
adicional
WG-2370395

CLICK & PAINT



338€

PP90 SKID HEA EXTRA

Tamaño boquilla: 0,019"
Flujo max.: 1,9 lt./min.
0,8 Kw.
WG-2414079

HEA HIGH EFFICIENCY AIRLESS



SUCCIÓN
DIRECTA DEL
RECIPIENTE



SCAN ME



1.099€

CP250M

Caudal: 1,25 lt./min.
Manguera: 9 mt.
Boquillas máx. 517
550 W.
WG-2371053
No recomendada
para productos
con base
disolvente.

HEA HIGH EFFICIENCY AIRLESS



474€

CP350R

Caudal: 1,50 lt./min.
Manguera: 15 mt.
Boquillas incluidas
311 - 517
600 W.
WG-2371073
No recomendada
para productos
con base
disolvente.

HEA HIGH EFFICIENCY AIRLESS



590€

CP350M

Caudal: 1,50 lt./min.
Manguera: 15 mt.
Boquillas incluidas
311 - 517
600 W.
WG-2371057
No recomendada
para productos
con base
disolvente.

HEA HIGH EFFICIENCY AIRLESS



641€

FURNO 100

Decapador
350 W.
Flujo de aire:
100-150 lt/min.
Temperatura :
230°C - 360°C
2 niveles de
temperatura
WG-2398546



33€

FURNO 300

Decapador
1.600 W.
Flujo de aire: 675 lt/min
Temperatura:
400°C - 575°C
2 niveles de
temperatura
WG-2359348



26€

FURNO 500

Decapador
2.000 W.
Flujo de aire
regulable hasta 800 lt/min
Temperatura: 60°C - 600°C
2 boquillas
12 niveles de temperatura
WG-2359352

Sistema de
auto-enfriamiento



48€

FURNO 750

Decapador
2.000 W.
Flujo de aire
regulable
hasta 820 lt/min
Temperatura:
50°C - 650°C
4 boquillas
Maletín
WG-2359358

Sistema de
auto-enfriamiento
Display digital



77€

85

LIJADORA STUDIO

TIPO MOUSE

130 W.
Longitud del cable 2 mts.
Dimensiones: 21x13x14 cm.
WG-2370395

Incluye
3 lijas



33€



Extensión Universal Extra

Prolongador del mango.
Ergonómico, para
trabajar cómodamente
en paredes y techos.
Ref.: WG-2361756

CLICK & PAINT



28€



FRONTAL GRAVEDAD

Depósito: 150 y 600 ml.
Para trabajos
pequeños
y medianos.
WG-2412884

CLICK & PAINT



33€

WG-517101

Pistola Airless Control
Pro metal.
WG-517101

179€



DISPOSITIVO BOQUILLA

Válido para Control Pro
WG-517200

30€



WG-517

Boquilla HEA Control Pro



49€

REFERENCIA	DESCRIPCIÓN
WG-517211	Boquilla Control Pro, 211 (Esmaltes, lacas, barnices)
WG-517311	Boquilla Control Pro, 311 (Esmaltes, lacas, barnices)
WG-517313	Boquilla Control Pro, 313 (Esmaltes, lacas, barnices)
WG-517413	Boquilla Control Pro, 413 (Esmaltes, lacas, barnices)
WG-517515	Boquilla Control Pro, 515 (Pinturas plásticas int.)
WG-517517	Boquilla Control Pro, 517 (Pinturas plásticas int.)
WG-517619	Boquilla Control Pro, 619 (Pinturas plásticas ext.)

EXTENSIÓN CONTROL PRO

REFERENCIA	LARGO (CM)	OFERTA
WG-517700	30	79,00 €
WG-517701	60	89,00 €



SET DE DOS FILTROS

REFERENCIA	COLOR	OFERTA
WG-418711	ROJO	19,00 €
WG-418712	AMARILLO	19,00 €
WG-418713	BLANCO	19,00 €



DISCO SPEED SHIELD

Disco recortador con soporte de boquilla rosca G.
WG-538905



135 €

QUITAPAPELES STEAMFORCE

2.000 W. Depósito: 4 l.
Tiempo vaporizado máx.: 80 min
WG-2410385



57 €

RODILLO DIY AUTOALIMENTADO

Depósito: 550 ml.
Rendimiento: 5 m2
Longitud: 1,25 m.
WG-2419944



34 €

RODILLO WG-0998230

Válido para WG-2419944
Ancho x largo: 230x12 mm.

6,42 €



RODILLO WG-0245717

Válido para WG-2419944
Ancho x largo: 230x20 mm.

6,42 €



ACCESORIOS PARA TODOS LOS SISTEMAS DE PULVERIZACIÓN

FRONTAL STANDARD

Depósito turbina
HVLP para esmaltes
y lacas
WG-2361730

CLICK & PAINT

800 ml.



23€

FRONTAL CORNER

Depósito turbina
HVLP para esmaltes y lacas
Fácil acceso a esquinas y
rincones
WG-2361742

CLICK & PAINT

600 ml.



23€

FRONTAL DETAIL

Depósito turbina
HVLP para esmaltes
y lacas
Preciso
WG-2361744

CLICK & PAINT

250 ml.



23€

FRONTAL LARGE

Depósito turbina
HVLP para esmaltes y lacas
Gran autonomía
WG-2361736

CLICK & PAINT

1.400 ml.



23€

FRONTAL BRILLIANT

Depósito turbina
HVLP para esmaltes y lacas
Acabado alta calidad
WG-2361738

CLICK & PAINT

600 ml.



23€



FRONTAL EXTRA I-SPRAY

Depósito turbina HVLV
para pinturas plásticas
Gran ancho de abanico
WG-2361746

CLICK & PAINT

1.300 ml.



36,38€

FRONTAL EXTRA I-SPRAY

Depósito turbina HVLV
para pinturas plásticas
Gran ancho de abanico
WG-2361749

CLICK & PAINT

1.800 ml.



36,38€

Asa CLICK&PAINT

Para frontales
Wall Extra.
WG-2362879



14,98€

Adaptador CLICK&PAINT

Para frontales.
WG-2315666



26,75€

89

Leyenda



Esmaltes, lacas
y barnices

ESPECIAL PARA APLICACIÓN DE
ESMALTES, LACAS Y BARNICES



Pinturas
plásticas

ESPECIAL PARA APLICACIÓN
DE PINTURAS PLÁSTICAS



HEA HIGH EFFICIENCY
AIRLESS

SISTEMA AIRLESS
DE BAJA PRESIÓN

Tecnología

CLICK & PAINT



GAMA INDUSTRIA

BT36TR

Bomba de trasvase. Ref.: BT-213601

36 l/min

CAUDAL	36 l/min
RELACIÓN	1:1
PRESIÓN	1:8 BAR
PESO	4 KG
CONEXIÓN	3/8"
MEDIDAS ENTRE TORNILLOS	15x10,5 cm

* Disponible BT-213601 Atex

389€



BT48TR

Bomba de trasvase. Ref.: BT-214801

48 l/min

CAUDAL	48 l/min
RELACIÓN	1:1
PRESIÓN	1:8 BAR
PESO	4 KG
CONEXIÓN	1/2"
MEDIDAS ENTRE TORNILLOS	16x12 cm

* Disponibles:
BT-214801 Acero Atex
BT-214805 Nylon Atex
BT-214804 Inox Atex

550€



BT-36

Bomba neumática doble membrana con carro.
Ref.: BT-213602

36 l/min

CAUDAL	36 l/min
RELACIÓN	1:1
PRESIÓN	1:8 BAR
PESO	13 KG
CONEXIÓN	1/2"
MEDIDAS ENTRE TORNILLOS	16x12 cm

Disponible mod. BT-48
(48 l/min.) Ref.: BT-214802
P.V.P.: 899 €

689€



Accesorios opcionales:

• BT-MU0933: Regulador 0-6 Bar
P.V.P.: 141,75€

• BT-S71PRONA: Pistola baja presión
1,3 mm. BT-S71PRONA1.3 P.V.P.: 104 €
1,5 mm. BT-S71PRONA1.5 P.V.P.: 104 €
1,8 mm. BT-S71PRONA1.8 P.V.P.: 104 €

• BT-886875: Manguera 7.5 mt
(1/4" - Rosca F) P.V.P.: 38,85 €

• BT-60012: Sistema de aspiración
P.V.P.: 44,10 €



BT-33200

Conjunto bomba especial para esmaltes.

DEPÓSITO	2 lt.
MANGUERA	3.5 mt
PISTOLA BAJA PRESIÓN	6,8 Bar max.
PRESIÓN MÁX.	3,5 Bar
CONEXIÓN	1/4"

147€



Accesorios opcionales:

• BT-S71PRONA: Pistola baja presión
1,3 mm. BT-S71PRONA1.3 P.V.P.: 104 €
1,5 mm. BT-S71PRONA1.5 P.V.P.: 104 €
1,8 mm. BT-S71PRONA1.8 P.V.P.: 104 €

• BT-886803: Manguera 3.5 mt
(1/4" - Rosca F) P.V.P.: 39€



SC-SG1000

Generador 230 V. - 650/700 W.
1,6 HP. Sistema de regulador de voltaje. (AVR) Motor gasolina. 4 lt. Motor 2 tiempos. 17,5 Kg.

1x230 V.

149€



SC-SG3200

Generador 230 V. - 2.500/2.800 W.
6,5 HP. Sistema de regulador de voltaje. (AVR) Protector sobrecargas, voltímetro y advertencia nivel de aceite. Motor gasolina. 15 lt. Motor 4 tiempos. 47 Kg.

2x230 V.

399€



SC-SG7100

Generador 400/230 V. - 5.000/5.500 W.
15 HP. Sistema de regulador de voltaje. (AVR) Protector sobrecargas, voltímetro y advertencia nivel de aceite. Motor gasolina. 25 lt. Motor 4 tiempos. 89 Kg.

1x230 V.
2x400 V.

899€



SC-SG2500I

Generador 230 V. 2.500 W.
2.86 HP. Inverter 71Db
Construcción compacta y ligera para un fácil transporte. Motor gasolina 3.2 Lt. Motor 4 tiempos. 21 Kg.

2x230 V.

619€



91

SC-DP55

Taladro de columna 13 mm.
230 V.
900 W. Digital
Motor inducción.
Velocidad: 500 - 2.600 r.p.m.

179€



SC-DP60

Taladro de columna 13 mm.
230 V.
900 W. Digital
Motor inducción.
2 velocidades. LED integrado

Velocidad variable

259€



SC-DH1300PLUS

Martillo 1.250 W.
5 Julios - 0-850 r.p.m.
4.500 golpes/min.
Max. diam broca SDS PLUS 30 mm.
4 funciones. Incluye brocas,
punta, cincel.
En maleta.
6 kg.

Rotativo
Picador



122 €

SC-DH12000MAX

Martillo 1.050 W.
9 Julios - 0-480 r.p.m.
3.780 golpes/min.
Max. diam broca SDS MAX 38 mm.
Incluye punta y cincel.
En caja de transporte
6 kg.

Rotativo
Picador



185 €

SC-AB1600

Martillo 1.600 W. 50 Julios.
Anti-vibración. Incluye
2 cinces. 16 kg.

Demoledor
Hexagonal
30 mm.
Maleta



229 €

SC-AB1900

Martillo 1.900 W. 60 Julios.
Anti-vibración.
Incluye ruedas, cincel y punta.
16,5 Kg.

Demoledor
Hexagonal
30 mm.
Maleta



249 €

SC-VS1000

Pisón. 6,5 HP - Gasolina.
10.000 N. Ancho
compactación: 345x285.
Vibración 450. 650 vpm.
Ruedas de transporte.
78 kg.

Profundidad de
compactación
40-60 mm.



1.375 €

SC-EB1700

Ahoyadora. 1,77 HP - Gasolina. 9.600 r.p.m.
Incluye 3 brocas
de 100 - 150 - 200 mm.
2 velocidades.
51,7 c.c.
22,5 Kg.

Máxima
perforación
800 mm.



320 €

Brocas:

SC-7904702701 - 100 mm. P.V.P.: 25 €

SC-7904702702 - 150 mm. P.V.P.: 28 €

SC-7904702703 - 200 mm. P.V.P.: 50 €

SC-HP1200S

Compactadora
6,5 HP. - Gasolina 15.000 N
Velocidad 25 m/min
Velocidad de trabajo: 600m²/h
Placa 450x350 mm.
196 c.c.
60 Kg.

Profundidad de compactación: 25 cm.

Ruedas de transporte



569€



SC-HP1800S

Compactadora
6,5 HP. Gasolina. 23.000 N.
Velocidad 25 m/min
Velocidad de trabajo: 650 m²/h
Placa 550x440 mm.
196 c.c.
88 Kg.

Profundidad de compactación: 30 cm.

Ruedas de transporte



689€



SC-HP2200S

Compactadora
6,5 HP. - Gasolina 25.000 N
Velocidad 25 m/min
Velocidad de trabajo: 650 m²/h
Placa 550x440 mm. 196 c.c.
102 Kg.

Profundidad de compactación: 35 cm.

Ruedas de transporte



732€



SC-HP2500S

Compactadora
6,5 HP. - Gasolina. 30.000 N
Velocidad 25 m/min
Velocidad de trabajo: 750 m²/h
Placa: 630x400 mm.
196 c.c.
125 Kg.

Profundidad de compactación: 40 cm.
Reversible

Ruedas de transporte



1.399€



SC-HP3000S

Compactadora
9 HP. - Gasolina. 30.500 N
Velocidad 25 m/min
Placa: 730x450 mm. 270 c.c.
161 Kg.

Profundidad de compactación: 50 cm.
Reversible

Ruedas de transporte



1.898€



SC-CB01

Polipasto cadena
Capacidad de carga: 1000 Kg.
Elevación: 3.000 mm.
Cadena de rueda
libre para controlar
la mano.

1.000 Kg



66€

SC-CB02

Polipasto cadena
Capacidad de carga: 2.000 Kg.
Elevación: 3.000 mm.
Cadena de rueda
libre para controlar
la mano.

2.000 Kg



99€

SC-HRS250

Polipasto eléctrico
230 V.
530 W.
Carga sin rodillo: 125 Kg.
Carga con rodillo: 250 Kg.
Altura de elevación
sin rodillo: 12 m.
Altura de elevación
con polea: 6 m.

125/250



149€

SC-HRS400

Polipasto eléctrico
230 V.
780 W.
Carga sin rodillo: 200 Kg.
Carga con rodillo: 400 Kg.
Altura de elevación
sin rodillo: 12 m.
Altura de elevación
con polea: 6 m.

200/400



195€

SC-DTB20-20PROS

Atornillador - percutor
Esfuerzo de torsión 45 Nm
Par de ajuste 18 + 3
Portabrocas 2 - 13 mm.
Velocidad 0 - 450/0 - 1600 min x 20 V.
Batería DC/2 Ah Lithium 220 - 240 V.
Cargador 50 - 60 Hz.

206 pzas.
Cargador
rápido



189€

SC-PL55

Sierra circular
230 V. - 240 V. 370 W.
Ø Eje: 20 mm.
Velocidad del disco: 5.500 r.p.m.
Corte máx. 90°: 55 mm.
Corte máx. 45°: 41 mm.

Ø Disco 160 mm.



236€

SC-PL75

Sierra circular
230 V. - 240 V. 1.600 W.
Ø Eje: 20 mm.
Velocidad del disco:
4.500 r.p.m.
Corte máx. 90°: 75 mm.
Corte máx. 45°: 55 mm.

Ø Disco 210 mm.



255€

SC-PLM1800

Cepilladora.
230 V. - 240 V. 1.500 W.
Anchura 330 mm. regreuso
Regreuso 152 mm.
Profundidad de pasada 2.8 mm.

Caja de
transporte



565€

2 Cuchillas: SC-7902200607 P.V.P.: 44,00 €

SC-HD12

Aspirador de ciclón
Potencia 550 W.
Caudal de aire 1.150 m3/h
Volumen 75 L, Ø
Longitud de manguera
100 mm. / 2.300 mm.

Con kit de
adaptadores



246,15 €

95

SC-OSM100

Lijadora oscilante
230 V. - 450 W.
Oscilación 16 mm.
Rodillo 12.7 mm.
R.p.m. 2.000



225€

SC-OSM600

Lijadora de banda y eje oscilante
230 V. - 240 V.
Rodillos Husillos 13 /19/26/38/51 mm.
Mesa ajustable 45°.
Juego de 6 rodillos:
C-7903400701 GR80
P.V.P.: 60 €
SC-7903400702 GR120
P.V.P.: 60 €
SC-7903400703 GR240
P.V.P.: 60 €
Juego de 3 Bandas 76 mm.
GR100. SC-7903400705
(80/100/120 mm.)
P.V.P.: 35 €

Oscilación
16 mm.
Maleta



289€

SC-DS920

Lijadora
710 W. - 230 V.
Velocidad variable 700 - 1.700 r.p.m.
Telescópica hasta 170 cm.
Conector 50 ext/45n

Ø 225 mm.
Luz



169 €

SC-DS200

Lijadora de pared y techo
1.200 W. - 230 V.
Velocidad variable 1.500 - 3.200 r.p.m.
Telescópica hasta 170 cm.
Conector 31 ext/28 mm. int
Con bolsa de aspiración

Ø 225 mm.



111,49 €

SC-PM1600

Mezclador
230 V.- 240 V.
1.600 W.
0.580/0.780 r.p.m.
Volumen máx. de
mezcla 140 Lt.

2 velocidades



115 €

Varilla: CE-H2A P.V.P.:15 €

SC-PM1800D

Mezclador doble varilla
230 V.- 240 V.
1.800 W.
0.450/0.790 r.p.m.
Volumen máx. de
mezcla 140 Lt.

2 velocidades



169 €

2 varillas: SC-5907802701 P.V.P.:35 €

SC-MT150

Tronzadora de metal
230 V.- 2.600 V.
Disco 355x25,4 mm.
Capacidad de corte
máx a 90° Ø 115 mm.
115x115 mm. / 137x100 mm.
Rango giratorio
45° - 0° - 30°
4.200 r.p.m.

Caja de transporte
Ø Disco 355 mm.



197 €

Disco hierro: DR350H
P.V.P.: 5 €

SC-TIGER5000HOMEKIT

Afiladora
230 V.- 240 V. 150 W.
Dimensión / ancho
de la muela abrasiva
200x40 mm.
Grano de la muela: K220
Disco de bruñir cuero
220x30 mm.
Velocidad de rotación:
115 min.



229 €

SC-HBS30X

Sierra de cinta para madera
230 V. - 350 W.
Cinta 1425x6,35x0,35 mm.
Corte 80x20 mm.
Velocidad 900 m/min
Mesa inclinable 0-45°



199€

SC-HBS261

Sierra de cinta para madera
230 V. - 500 W.
Cinta 1790x13x0,35 mm.
Corte 120x245 mm.
Velocidad 660/960 m/min
Mesa inclinable 0-45°



335€

SC-HBS400

Sierra de cinta para madera
230 V. - 350 W.
Cinta 2240x130x5 mm.
Corte 170x305 mm.
Velocidad 660x960 m/min
Mesa inclinable 0-45°



669€

SC-BASA1

Sierra de cinta para madera
230 V. - 300 W.
Cinta 1490x12x0,36 mm.
Corte 100x195 mm.
Velocidad 880 m/min
Mesa inclinable 0-45°



279€

SC-BASA3

Sierra de cinta para madera
230 V. - 800 W.
Cinta 2306x12x0,5 mm.
Corte 205x306 mm.
Velocidad 370x750 m/min
Tabla ajustable 8-45°



Disponible versión 380 V.
y 700 W. P.V.P.:879 €

879€

CINTAS BIMETÁLICAS

REFERENCIA	VÁLIDA PARA	MEDIDAS	OFERTA
SC-7901504611	SC-HBS30X	1425 x 6,35 x 0,3 mm Z6	12,00 €
SC-7901504609	SC-HBS30X	1425 x 6,35 x 0,3 mm Z10	12,00 €
SC-7901504610	SC-HBS30X	1425 x 6,35 x 0,3 mm Z15	12,00 €
SC-7901505701	SC-HBS261	1790x10x 0.35 mm Z6	14,00 €
SC-3901502141	SC-HBS400	2240 x 13 x 0,5 mm Z4	21,00 €
SC-3901502702	SC-HBS400	2240 x 6 x 0,5 mm Z6	23,00 €
SC-3901502703	SC-HBS400	2240 x 6 x 0,4 mm Z24	24,00 €
SC-73220701	SC-BASA1	1490 x 12 x 0,36 mm Z4	25,00 €
SC-73220702	SC-BASA1	1490 x 10 x 0,36 mm Z14	25,00 €
SC-73220703	SC-BASA1	1490 x 6 x 0,36 mm Z24	25,00 €
SC-73220704	SC-BASA1	1490 x 6 x 0,36 mm Z6	25,00 €
SC-73220705	SC-BASA1	1490 x 3 x 0,45 mm Z14	36,00 €
SC-73190701	SC-BASA3	2360 x 12 x 0,5 mm Z4	28,00 €
SC-73190706	SC-BASA3	2360 x 3,5 x 0,5 mm Z14	42,00 €
SC-73190702	SC-BASA3	2360 x 6 x 0,5 mm Z6	26,00 €
SC-73190707	SC-BASA3	2360 x 6 x 0,85 mm Z22	24,00 €
SC-73190705	SC-BASA3	2360 x 12 x 0,5 mm Z6	28,00 €
SC-73190704	SC-BASA3	2360 x 15 x 0,5 mm Z4	36,00 €

SC-HS100S

Sierra de mesa
230 V. 2000 W.
Motor eléctrico
Corte a 45°: 65 mm.
Corte a 90°: 85 mm.

Ø Disco 250 mm.



255€

SC-HS105

Sierra de mesa
2.000 W. - 230 V.
Corte a 45° - 50 mm.
Corte a 90° - 75 mm.
Mesa: 640x920 mm.

Ø Disco 255 mm.



349€

SC-HS1200

Sierra de mesa
230 V. 2200 W.
Motor eléctrico
280 r.p.m.
Corte a 45°: 49 mm.
Corte a 90°: 83 mm.
Mesa: 800x550 mm.

Ø Disco 315 mm.



359€

SC-BTS900

Lijadora banda de disco 150 DM
230 V. 370 W.
Motor inducción
Banda de la lija 915x100 mm.



229€

SC-SD1600V

Sierra de marquetería
230 V.- 120 W.
Corte máx. 50x406 mm.
550- 1700 r.p.m.
Inclinable 45°

LED



149€

SC-DECO-XLS

Sierra de marquetería
230 V.- 125 W.
Corte máx. 50x406 mm.
550- 1600 r.p.m.
Inclinable 45°
Pedal de regulación de velocidad

LED



199€

SC-BCH5200PB

Desbrozadora 2 en 1
Motor 1,8 HP - 51,7 c.c.
Ancho de corte 450 mm.
Tamaño de cuchilla 255 mm.
Tanque 1 lt.
Peso 8,3 Kg.

2 en 1
Gasolina



199€

SC-MFH5200-4P

Dispositivo multi-jardín 4 en 1
Motor 1,8 HP - 51,7 c.c.
Ancho de corte:
450 mm.
Tamaño de cuchilla:
255 mm.
Tanque 1 lt.
Peso 12,5 Kg.

4 en 1
Gasolina



289€

SC-CPS2540

Motosierra
Motor 0,95 HP - 25,4 c.c.
Corte máx. 20 mm.
Depósito 0,23 lt.
Tensión de cadena Si
Peso 8,3 Kg.

Espada 25 mm.
Gasolina



159€

SC-CPS41

Motosierra
Motor 1,9 HP - 41 c.c.
Corte máx. 37,5 mm.
Depósito 0,26 lt.
Tensión de cadena Si
Peso 5,7 Kg.

Espada 40 mm.
Gasolina



175€

99

SC-CSH46

Motosierra
Motor 2,45 HP - 46 c.c.
Corte máx. 43 mm.
Depósito 0,55 lt.
Tensión de cadena Si
Peso 5,7 Kg.

Espada 46 mm.
Gasolina



195€

SC-GS55

Trituradora
Motor 2400 W. - 230 V.
4.100 r.p.m.

2 cuchillas:
Máx. 45 mm.



169€

BIENVENIDO A LA CASA CONECTADA

Canal Youtube
¡Visita nuestro canal para ver todos nuestros vídeos de instalación y todos nuestros consejos!



Servicio técnico – SAT
Accede a nuestros datos de contacto para ayudarte en la instalación o resolverte las dudas sobre cualquier producto Energeeks

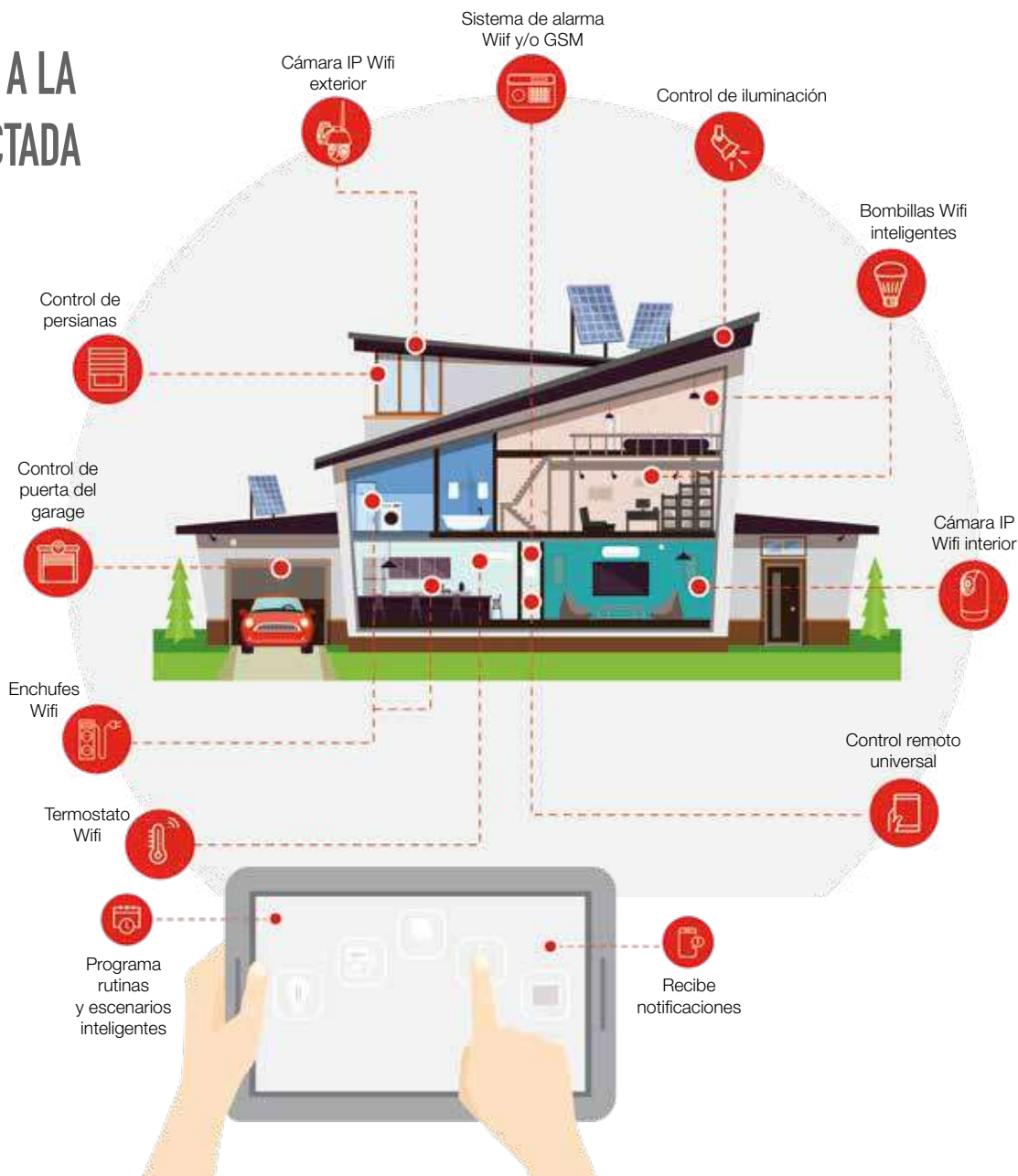

LEYENDA ICONOS

Control por voz	Ahorro energía	Control individual	Luz multicolor	Multi-dispositivo	3680 W 16A máx.	Programable
Notificaciones	Rotación 355° horizontal 90° vertical	Multisensor inalámbrico	Batería de respaldo	Datos extraíbles	Sin cuotas	GSM (SIM no incluida)
Control a distancia	Video en directo	Grabador 1Tb	Crea escenarios	App gratuita	Sensor de movimiento	Ahorro energía
WIFI 2,4 Ghz	Botón On-Off	Protección interior/externo	Visión nocturna (hasta 10 m)	Foco LED	Ranura Micro SD. Máx. 64 Gb (no incluida)	180°
Sensor crepuscular	Sin cables	Batería 9.000 mAh	Amazon Alexa y Google Assistant	15.000H	x50.000	55°



SCAN ME

EG-EW003MC
Enchufe Wifi inteligente con medidor de consumo.



14,50€

Pack 3 uds.:
EG-EW004MC
OFERTA: 39 €

EG-EW006MC
Enchufe Wifi doble inteligente



20,50€

Enchufe doble

EG-EW005MC
Enchufe Wifi inteligente con 2 Usb.



16€

2 Usb

EG-EW001MC
Enchufe Wifi inteligente con luz multicolor.



16€

Luz multicolor

EG-BW001MC
Base múltiple inteligente 4T+4x USB



36€

4 Usb

EG-IR001
Control remoto universal Wifi.



18€

Control A/A a distancia

EG-A60BOMBW001
Bombilla Wifi inteligente A60. Casquillo E27. 806 Lm. 9 W. Bluetooth RGB+CCT

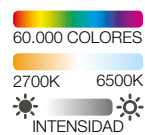

8,99€



EG-GU10BOMBW001
Bombilla Wifi inteligente GU10. 345 Lm. 5 W. Bluetooth RGB+CCT

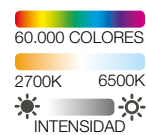

8,99€



EG-MODPERS001
Módulo Wifi para persianas. Control a distancia de persianas motorizadas. 10A - 2300W máx. Con instalación específica, no condensa el interruptor.



19,95€

EG-MODILU001
Módulo Wifi ON/OFF. Control a distancia de cualquier dispositivo ON / OFF, circuito de luces o lámpara de techo. 10A - 2300W máx. Con instalación específica, no condensa el interruptor.



16,95€



SEGURIDAD

EG-AW002 PLUS

Sistema de alarma Wifi 3.0
 Conexión wifi.
 Avisos de intrusiones y control desde un smartphone.
 Ampliable con hasta 60 sensores y/o accesorios y compatible con cualquiera de nuestras cámaras.

Control desde el teléfono móvil

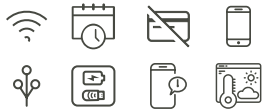

129€



ACCESORIOS ADICIONALES Y CÁMARAS COMPATIBLES PARA EG-AW002 PLUS Y EG-AWG002

Accesorios

Mando a distancia
 Ref. EG-MD002

10€



Sensor de apertura
 Ref. EG-SA002

12€



Sensor de movimiento
 Ref. EG-SM002

17€



Sirena exterior
 Ref. EG-S002

40€



Cámaras

EG-CIP001



EG-CIP002



EG-CIPEXT001



CIPBAT001



CIPFOCO001



CIPFOCO002



EG-AWG002

Sistema de alarma Wifi + GSM
 Dispone de una batería de emergencia y automáticamente, pasa a modo GSM.
 Ampliable con hasta 60 sensores y/o accesorios y compatible con cualquiera de nuestras cámaras.

GSM con SIM y/o WIFI
 Control desde el teléfono móvil



139€

* Tarjeta SIM no incluida.





SCAN ME

VIDEOVIGILANCIA

EG-CIP001

Cámara IP WIFI motorizada.

Visualiza en directo desde tu móvil

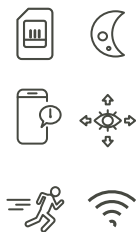

28€

EG-CIP002

Cámara IP WIFI motorizada SENTINEL 1080 p. RJ45

Función autotracking



39€

EG-CIPEXT001

Cámara IP WIFI motorizada exterior DEFENDER 1080p. RJ45

IP65
Wifi
Para exterior
Función autotracking



66€

EG-CIPBAT001

Cámara IP Wifi con batería recargable RANGER

IP65
Interior / Exterior
Batería 9000 mAh
Soporte imantado



79€

EG-CIPFOC001

Cámara IP Wifi con foco OBSERVER

IP65
Exterior
800 - 1000 Lm

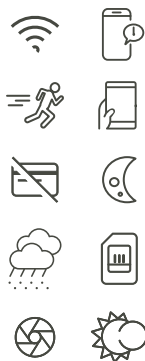

69€

EG-CIPFOC002

Cámara IP Wifi con doble foco OBSERVER II

IP65
Exterior
2500 - 3000 Lm

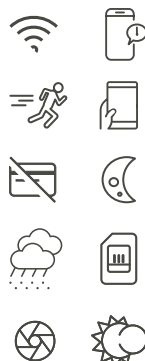

119€

VIDEOVIGILANCIA

EG-CCTV001PLUS

Sistema de vigilancia.
CCTV FULL HD
(4 cámaras + DVR 4 canales)

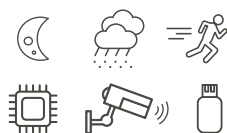

309€

MINI ALARMAS

ALARMA TIMBRE SIN HILOS
con detector de movimiento
Ref. EG-ALT001



15,95€

ALARMA DE APERTURA
para puertas y ventanas
Ref. EG-AL001



9€

ALARMA DE APERTURA
para puertas y ventanas
con mando a distancia
Ref. EG-AL002



18€

PACK DE 4 ALARMAS
de apertura para puertas
y ventanas
Ref. EG-AL006



4,50€

ALARMA PERSONAL
Ref. EG-ALV001



3,50€

ALARMA TIMBRE
con detector de movimiento
Ref. EG-ALT002



7€

ALARMA DE APERTURA
para puertas y ventanas
con teclado
Ref. EG-AL003



20€

ALARMA DE VIBRACIÓN
ANTI-INTRUSIÓN
Ref. EG-AL004



11€

ALARMA ANTI-INTRUSIÓN
para puertas y ventanas
de cristal
Ref. EG-AL005



6€

ALARMA ANTI-INTRUSIÓN
para pomo/manilla puertas
Ref. EG-ALV002



3,70€

ALARMA ANTI-INTRUSIÓN
tope de puertas
Ref. EG-ALV003



2,99€



SCAN ME

CONTROL DE TEMPERATURA

EG-VALVKIT001

Pack inicial válvula termostática. Control de radiador individual. Programación, escenarios. Control a distancia. **IMPORTANTE:** Se necesita tener previamente una llave termostática instalada en el radiador.



109€

EG-VALV001

Válvula termostática adicional. Control de radiador individual. Programación, escenarios. Control a distancia. **IMPORTANTE:** Se necesita tener previamente una llave termostática instalada en el radiador.



39,95€



EG-TERM001

Termostato WIFI. Control de calderas individuales. Control a distancia. Se puede instalar en la pared, sustituyendo al actual, o de sobremesa.



89€



INSTALACIÓN SOBREMESA: CENTRAL WIFI A LA CALDERA

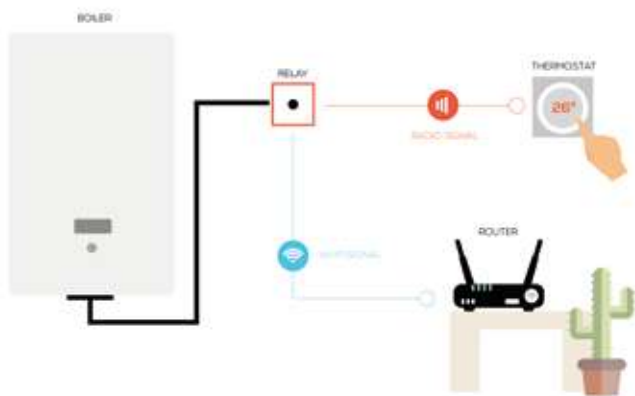

INSTALACIÓN PARED: TERMOSTATO A LA CALDERA



DECORATIVA EXTERIOR

EG-GRL5230VB

Guirnalda exterior 5 mt. 10 casquillos

E27



24,20 €

EG-GRL5230VW

Guirnalda exterior 5 mt. 10 casquillos

E27



27,50 €

PACK5EEGRLPRVBJ

Pack 5 bombillas para guirnalda multicolor 1.2 W.

E27



RGB LED

7,69 €

EG-SE40GAM

Bombilla antimosquitos. LED 6,8 W. 680 lúmenes



3,85 €

106

EG-GRL5PRVBT

Guirnalda exterior 5m/5 bombillas 1.2 W.



RGB LED

17,60 €

EG-GRL5PCWT

Guirnalda exterior 5m/5 bombillas led 7000 K. - 1.2 W.

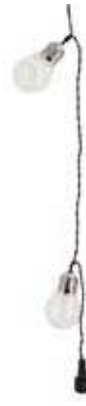

Luz fría

17,60 €

EG-LP545

Luz led con velcro y pilas. 5 LED. Autónoma. 2700 K 1.2 W.

3AAA



6,05 €

PV-BL5475

Pack 3 luces LED adhesivas.

Para uso interior



6,59 €

PV-BL6885

Pack 6 luces LED adhesivas.

Para uso interior



10,99 €

DECORATIVA EXTERIOR

EG-PR10WR

Proyector recargable.
700 lúmenes.

38,50€



PR20WR

Proyector recargable.
1400 lúmenes.

57,20€



EG-PR20WT

Proyector
trípode LED.
1.600 lúmenes.
20 W.

38,50€

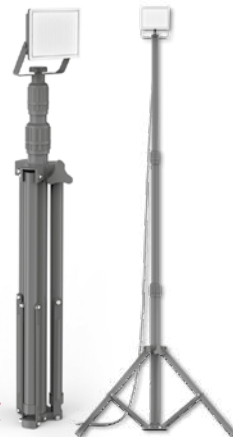

EG-PR20W2T

2 proyectores
trípode LED.
1.400 + 1.400
lúmenes.
20 W. + 20 W.

47,30€



EG-PR10WF

Proyector LED
10W.
800 lúmenes.

Hasta 30 mt.

19,80€



EG-PR30WF

Proyector LED 30W.
2400 lúmenes.

Hasta 50 mt.

27,50€



EG-PR50WF

Proyector LED 50W.
4000 lúmenes.

Hasta 70 mt.

35,20€



EG-PR10WM

Proyector de pared LED
exterior 10W.
800 lúmenes.

Hasta 30 mt.



10,99€ IP65 WATER RESIST

EG-PR30WM

Proyector exterior
LED 30W.
2400 lúmenes.

Hasta 50 mt.



16,50€ IP65 WATER RESIST

EG-PR50WM

Proyector exterior
LED 50W.
4000 lúmenes.

Hasta 70 mt.



19,80€ IP65 WATER RESIST

EG-PR20WMD

Proyector de pared
LED exterior. 50
W. 1600 lúmenes.
Con sensor de
movimiento.

Hasta 40 mt.



19,80€ IP44 WATER RESIST

EG-PR50WMD

Proyector de pared
LED exterior. 50
W. 4000 lúmenes.
Con sensor de
movimiento.

Hasta 40 mt.



26,40€ IP44 WATER RESIST

EG-PR20WMRVB

Proyector de
pared LED
exterior. 15W.
1300 lúmenes.

Hasta 50 mt.

RGB LED



37,40€ IP65 WATER RESIST

LINTERNAS

EG-FR100

Linterna frontal LED 100 lúmenes. Pilas incluidas.

Hasta 15 mt.



2 MODOS
50% | 100%



5,50€

EG-LP1072

Linterna portátil con cargador. 200 lúmenes. Pilas incluidas.

Hasta 10 mt.



COLGADOR

2 MODOS
50% | 100%



2AA



ORIENTABLE 360°



MAGNÉTICO



5,50€

EG-BL222

Linterna LED con colgador. 200 lúmenes. Pilas incluidas.

Hasta 8 mt.



MAGNÉTICO



COLGADOR

2 MODOS
50% | 100%



3AAA



RESISTENTE



9,90€

EG-LT250M

Linterna LED retráctil. 250 lúmenes. Pilas incluidas.

Hasta 20 mt.



3AAA



COMPACTA



8,80€

EG-T0100XS

Linterna LED metálica. 100 lúmenes. Pilas incluidas.

Hasta 70 mt.



6,60€



IP63

WATER RESIST



1AA

EG-T0600M

Linterna LED metálica. 600 lúmenes. Pilas incluidas.

Hasta 200 mt.

3 MODOS
50% | 100% | FLASH



11€



IP65

WATER RESIST

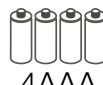

4AAA

EXTERIOR SOLAR

EG-LSBK3SOLARRVB

Tira LED 3 mt.

RGB LED



27,45€

EG-LSAK3SOLAR

Tira LED 3 mt.

Luz fría



27,45€

EG-S01017

Pack 8 balizas blanco/RGB.

Hasta 8 h.



29€

EG-PACK2PSO350

Pack 2 focos LED.

Hasta 8 h.

37,40€



EG-PRS700D

Foco solar con sensor de movimiento. Detección a 5 m. 700 lúmenes

Luz fría



32,95€

EG-APS300

Foco-aplique solar con sensor de movimiento. Detección a 7 m. 300 lúmenes.

Luz fría



23,10€

EG-SORETRO3

Bombilla decorativa solar

Hasta 8 h.



7,70€

DECORATIVA INTERIOR

EG-SDVEL

Lámpara pendel latón
Casquillo E27



10,95 €

EG-SDV03EB

Lámpara pendel aluminio
Casquillo E27



10,95 €

EG-SDVEG

Lámpara pendel dorada
Casquillo E27



10,95 €

EG-RFDHE150BCAN

Bombilla deco rejilla oval negra
Casquillo E27



18,15 €

EG-RFDHE150ECAN

Bombilla deco rejilla esfera negra
Casquillo E27



18,15 €

EG-RFDHE150CCAN

Bombilla deco rejilla cilíndrica negra
Casquillo E27



18,15 €

EG-RFDHE150BCAB

Bombilla deco rejilla oval blanca
Casquillo E27



18,15 €

EG-RFDHE150ECAB

Bombilla deco rejilla esfera blanca
Casquillo E27



18,15 €

EG-RFDHE150CCAB

Bombilla deco rejilla cilíndrica blanca
Casquillo E27



18,15 €

EG-RFDE280B125S

Bombilla LED deco espiral
Casquillo E27
1800K
300 lúmenes
4W (equivalente
28W)



12,64 €

EG-RFDE300BLG

Bombilla LED deco vintage verde
Casquillo E27
2200K
340 lúmenes
8W
(equivalente
28W)



17,60 €

EG-RFDE806GB0CW

Bombilla LED deco opalina
Casquillo E27
4000K
806 lúmenes
8W (equivalente 60W)



19,99 €

VINOLO ADHESIVO PARA SUELO		OFERTA 5 uds.
F-30006MAK	1000X100 mm A/N	3,99 €
F-30007MAK	1000X100 mm R/B	
F-30008MAK	1000X100 mm A/N	
F-30012	Ø 30 mm Amarillo	

Antideslizantes



Ref.: F-30006MAK



Ref.: F-30007MAK



Ref.: F-30008MAK



Ref.: F-30012

CINTA ADHESIVA			OFERTA
F-112	Base polipropileno N/A 0,5x66 mt	36 uds	2,09 €
F-117	Base polipropileno R/B 0,5x66 mt	36 uds	2,09 €
F-136	Base caucho B/R 0,5x33 mt	24 uds	7,56 €
F-137	Base caucho N/A 0,5x33 mt	24 uds	7,56 €



*Impresión 1 cara en rojo o negro.

SEÑALIZACIÓN COMBINADA		
F-614	Adhesivo "Lavado de manos"30x40cm.	10 uds
F-617	Adhesivo "Aforo máximo"40x30cm.	10 uds
F-618	Adhesivo "Aforo limitado"40x30cm.	10 uds
F-621	Adhesivo "Normas de seguridad"30x40cm.	10 uds

UNIDAD
1,99 €

Estas señales se pueden fabricar en PE, adhesivo o aluminio



F-618



F-617



F-614



F-621

SHOPGEL HIDROALCOHÓLICO

Gel/Jabón líquido neutro a base de alcoholes para la higienización de las manos. Válido para uso en áreas de manipulación de alimentos. No necesita aclarado. Transparente y sin perfume. Contiene glicerina.

Limpiador
Higienizante
Protector



Ref.: F-143/500ML

0,5L

UNIDAD
3,69€

Pedido mínimo 25 uds.



Ref.: F-143/1LT

1L

UNIDAD
4,19€

Pedido mínimo 12 uds.



Ref.: F-143/5LT

5L

UNIDAD
16,80€

Pedido mínimo 4 uds.

F-143P305

Alcohol isopropílico se puede usar como limpiador, desengrasante o disolvente para eliminar todo tipo de suciedad, rayas, huellas dactilares de las superficies, dispositivos electrónicos, teléfonos móviles, dispositivos ópticos... etc. Se evapora rápidamente sin dejar residuos. Pedido mínimo 12 uds.

400 mL

UNIDAD
5,99€



Transparente
Sin perfume
Pureza del 90%

CE-E010SST

Generador de ozono O₃. Temporizador con 16 programas. Programación diaria o semanal. Acero.

PRODUCCIÓN DE OZONO (gr)	10
VENTILADOR (m ₃ /h)	115
VOLTAJE (V)	220-240
FRECUENCIA (Hz)	50/60
POTENCIA (W)	85
LpA SONORO 3 mt. (dB(A))	52
LONGITUD DEL CABLE (m)	3.0

Cobertura máx.
desinfección:
200m² en 1h.
Suministro inmediato
desde que se enciende
el interruptor

EUO₃TA.org
European Ozone Trade Association



586€

CE-E010WTH

Generador de ozono O₃. Temporizador con 16 programas. Programación diaria o semanal. Inoxidable.

PRODUCCIÓN DE OZONO (gr)	10
VENTILADOR (m ₃ /h)	115
VOLTAJE (V)	220-240
FRECUENCIA (Hz)	50/60
POTENCIA (W)	85
LpA SONORO 3 mt. (dB(A))	52
LONGITUD DEL CABLE (m)	3.0

Cobertura máx.
desinfección:
200m² en 1h.
Suministro inmediato
desde que se enciende
el interruptor

EUO₃TA.org
European Ozone Trade Association



651€

G140-61N
Nobuk.
Tallas 36 a 47

S3 SRC
Metal FREE



59€



G138107C
Serraje.
Tallas 36 a 47

S1P SRC



29€



G138106C
Serraje.
Tallas 36 a 47

S1P SRC



28,50€



G140-60N
Nobuk.
Tallas 36 a 47

S3 SRC
Metal FREE



59€



GYSHU1500C
Tejido Mesh.
Tallas 37 a 47

SRA S1P HRO
Metal FREE



55€



GYSHU1504N
Tejido Mesh.
Tallas 36 a 47

S1P SRA
Metal FREE



59€



GYSHU1502N
Tejido Mesh.
Tallas 36 a 47

S1P SRA
Metal FREE



59€



GYSHU1503N
Tejido Mesh.
Tallas 36 a 47

S1P SRA
Metal FREE



59€



GYSHU1506N
Tejido Mesh.
Tallas 36 a 47

S1P SRA
Metal FREE



59€



G138840C
Serraje.
Tallas 36 a 48

S1P SRC
Metal FREE



39€



G1388601C
Nobuk.
Tallas 35 a 47

S3 SRC
Metal FREE



44€



G1388602C
Nobuk.
Tallas 35 a 47

S3 SRC
Metal FREE



45€



G140-40PC

S3 SRC

Piel flor negra. Puntera de composite y plantilla anti-perforante. Tallas 36 a 42



39€



G140-41PC

S3 SRC

Piel flor negra. Puntera de composite y plantilla anti-perforante. Tallas 36 a 42



38€



ZF140-50VF

S1P SRA

Piel serraje negro. Puntera de composite y plantilla anti-perforante. Tallas 36 a 47



35€



ZF138-10F

S1P SRC

Piel serraje gris. Puntera y plantilla acero. Tallas 36 a 47



23€



ZF-60055S

S1P SRA

Piel negro, puntera y plantilla acero inox. Tallas 36 a 48



21€



ZF-50066S

S1P SRA

Piel negro, puntera y plantilla acero inox. Tallas 36 a 47



21€



AR-132/RNG

Nylon / PVC

Traje impermeable verde Tallas M-L-XL-XXL.



9,99 €

MONO MULTIBOLSILLOS

Tallas S-M-L-XL-XXL.

- F-991210 AZULINA
- F-991211 MARINO
- F-991212 CAQUI



14,95€

F-991121

Chaleco multibolsillos de nylon reforzado.



11,55 €

AR-140/161

S5 SRA

Bota de agua verde, con puntera y plantilla acero. Tallas 37 a 47

PVC



19,95 €

DUNLOP
PROTECTIVE FOOTWEAR

G348843C

Guantes nylon elástico verde. Palma recubierta de espuma de latex
Tallas 8 y 10

Látex



1,82 €

G0529

Guantes de hilo continuo elástico gris en nylon con spandex y palma recubierta de espuma de nitrilo negra.
Con puntos antideslizantes.
Tallas 8-9-10.

Nitrilo



2,30 €

G34874C

Guantes de nylon elástico gris con palma recubierta de espuma de nitrilo negra.
Tallas 8-9-10

Nitrilo



2,10 €

G348841C

Guantes de nylon elástico azul, con palma recubierta de espuma de látex gris.
Tallas: 8-9-10

Látex



1,58 €

G34894C

Guantes de hilo continuo elástico negro con palma y dorso recubierto de espuma de nitrilo doble recubrimiento. Palma estriada.
Tallas: 8-9-10

Nitrilo



2,99 €

F-121/15

Guantes polietileno desechables de 0,9 grs/m. Pedido mínimo: 10.000 uds. En bolsas individuales de 100 uds.



0,89 €



F-057C

Guantes en hilo continuo de nylon, recubierto de nitrilo gris, sin costuras. Óptima sensibilidad.
Tallas 8, 9 y 10



0,85 €

F-05270C

Guantes en nylon elástico, con la palma recubierta de poliuretano negro, puños de nylon y látex. Dorso aireado.
Tallas 8, 9 y 10



0,79 €

F-0525C

Guantes en nylon elástico, con la palma recubierta de poliuretano blanco, puños en nylon y látex. Dorso aireado.
Tallas 8, 9 y 10



0,85 €

F-005BC

Guantes en piel flor de vacuno, blancos con ribete. Discreta sensibilidad
Espesor de la piel: 0,8 - 1 mm.
Tallas 8, 9 y 10



2,19 €

AR-1390Y

Guantes en tejido interlock algodón 100%, impregnado de NBR ligero, puño en malla, dorso ventilado. Buena sensibilidad. Talla 8



0,99 €

F-020

Guantes en serraje vacuno, manguito en tela reforzado, dorso algodón 100%. Palma, pulgar e índice reforzados. Espesor de la piel: 1,2-1,3 mm. Óptima sensibilidad. Talla XL



1,67 €

F-039

Guantes 88PBS en piel flor de cerdo gamuza, dorso y manguito en algodón 100%. Espesor piel flor de: 0,8-0,9 mm. Buena sensibilidad. Tallas 8 y 10

Piel Flor



0,74 €

F-992002

Rodilleras de goma espuma negra. Sujeción con banda plástica ajustable.

Básica



8,80 €

F-992008

Rodilleras profesionales con gel de silicona en su interior. Sujeción con banda ancha de velcro.

Confort



16,50 €

F-992016

Rodilleras profesionales. Sujeción con bandas elásticas y cierre velcro.

Flexible



13,20 €

115

AR-235371010000

Mascarilla sin válvula (caja 20 uds.)

FFP1
Bajo pedido



16 €

AR-2353720100

Mascarilla sin válvula (caja 20 uds.)

FFP2



18 €

AR-2353730400

Mascarilla sin válvula (caja 20 uds.)

FFP3



41 €

AR-2353710300UD

Mascarilla con válvula (caja 12 uds.)

FFP1
Bajo pedido



13 €

AR-23537203500

Mascarilla con válvula (caja 12 uds.)

FFP2



15 €

AR-125F

Mascarilla con válvula (caja 12 uds.)

Alta Toxicidad
FFP3



27 €

AR-2351745100

Mascarilla con 1 filtro de gas A1 745 incluido.



11,03€

AR-2351755801

Mascarilla con 2 filtros de gas A1B1E1K1 incluidos.



24,15€

AR-142/40F

Mascarilla de caucho termoplástico. Con 2 filtros de gas A1 incluidos.



13,64€

AR-142/37F

Mascarilla de caucho termoplástico. Con 2 filtros de gas A2P3 incluidos. Especial fitosanitario.



24,15€

AR-732N

Máscara facial completa de silicona. (No incluye filtros)



66,15€

* Consultar gama y precios de filtros para las diferentes mascarillas.

116

AR-569-I

Gafa en policarbonato incoloro con el frente de una sola pieza y tira frontal de poliamida azul. Patillas extensibles tipo espátula. Protección lateral. Resistente al impacto de pequeños proyectiles.



2,60€

AR-580-I

Gafa monolente incolora en policarbonato. Se pueden sobreponer a las gafas de vista. Ideal para visitantes. Tratamiento anti-vaho y anti-arañazos.



1,99€

F-1422988

Gafa en policarbonato incoloro. Patillas regulables. Tratamiento anti-vaho y anti-arañazos.



3,50€

AR-599-G

Gafa de policarbonato panorámica gris.



5,85€

F-142/2503

Gafa máscara policarbonato incoloro. Especial sustancias químicas.



6,60€

F-142/40

Gafa máscara con montura integral en policarbonato. Lente panorámica anti-vaho y anti-arañazos. Ventilación directa a través de agujeros.



1,70€

AR-5RG

Casco de protección de polietileno alta densidad con regulador. Incorpora banda anti-sudor. Varios colores.

 AR-5RGL

 AR-5RGAM

 AR-5RGAZ



4,25€

AR-5R

Casco de obra en polietileno ajustable. Varios colores.

 AR-5RBL  AR-5RAM

 AR-5RAZ  AR-5RRO



2,19€

F-C/19

Pantalla protectora de acetato transparente de 30 micras con banda de polietileno regulable.



4€

F-142/210

Visera policarbonato transparente con elástico. Eficaz protección contra impactos de alta velocidad (baja y media energía) y salpicaduras.



3,99€

F-142/2100

Visera policarbonato transparente con arnes regulable. Eficaz protección contra impactos de alta velocidad (baja y media energía) y salpicaduras.



5,99€

F-142/110-15

Gorra de protección tipo "beisbol", antigolpes (protege la cabeza). Diseño en tela (100% algodón) con protección interior en ABS acolchado. Orificios de ventilación.



8,99€

117

AR-CHSR

Barboquejo con mentonera. Válido para cascos de protección AR-5RG y AR-5R.



1,49€

F-142/25

Auricular anti-ruido SNR-27 db.(*) Con almohadilla para mayor comodidad y mejor adaptación.



4,85€

F-142/250

Auricular anti-ruido profesional SNR-29db.(*) Diadema resistente. Acolchados en goma y tejido suave. Regulación de altura de las copas.



6,99€

CX-2651010100

Arnés anti-caídas. 10 BASIC
Cinta de 45 mm.
Hebillas de regulación
de piernas

13€



CX-2651010200

Kit Arnés 10 BASIC
+Mosquetones

21€

CX-2651043100

Arnés anti-caídas
ATLAS.
Cintas de poliéster
de 45 mm.
Cinturón y perneras
acolchadas. 3 aros
porta-materiales.
Hebillas de
regulación.

140 Kg.



125€

CX-2651252100

Arnés anti-caídas
MAXIPRO
Punto de anclaje en
dorsal en hebilla "D"
de acero de 8 mm.
Punto de enganche
frontal compuesto
por dos gazas. Banda
dorsal acolchada.



32€

CX-2651025200

Cinturón de sujeción 25-CN
Banda dorsal
acolchada con
hebillas.
Con cuerda
reguladora
y mosquetón.



29€

CX-2651259100

Línea de vida horizontal HORIZONT
Cinta de poliéster naranja de 35 mm.
Longitud 20 m. Elemento de trincaje
tipo carraca con doble bloqueo de
seguridad.



51€

CX-2702111120

Línea de vida vertical SEMI 11
Longitud 20 m.

54€

CX-2702111150

Línea de vida
vertical SEMI 11
Longitud 50 m.



155€

CX-2702003200

Absorbedor de energía. 31-A
Longitud 1,6 m. Con dos
mosquetones. Mod.30 y Mod. 31.

36€

CX-2702003800

Absorbedor de energía. 31-A
Longitud 1,6 m. Con dos
mosquetones mod.30

22€



CX-2702101100

Elemento de amarre
U.29/1 SEMI
Cuerda de poliamida
de ø11 mm. y gaza
a cada extremo.

1,5 mt.



10,50€

CX-2702100601

Absorbedor de energía 35 SEMI
Con banda de absorción y
elemento de amarre en Y de
poliamida de 11 mm.
3 conectores: 1 del mod. 32
y 2 del mod. 31.
Válido para arnés
21CATEX

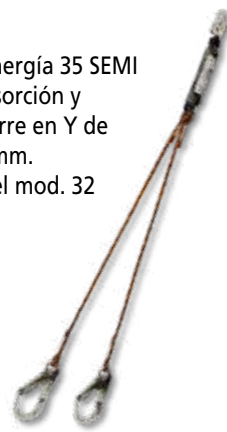

67€

CX-2702005110

Línea de anclaje
flexible. Para uso
vertical. Poliamida
de 3 cabos. 115 gr/m.
Acabados: Lazada
y nudo terminal o
guardacabos en los
extremos ø 14 mm.
Longitud a demanda.



29€

CX-2702003100

Dispositivo anti-caídas deslizante
ADA 14. Con cierre
de seguridad.
Longitud: Con
cuerda de 10 a
100 m, en
tramos de 10 m.



45€

CX-2707001400

Dispositivo anti-caídas ROC
Aluminio anodizado. Para
cuerdas de 10,5 a 12,7 mm.
homologadas.



56€

CX-2703001100

Mosquetón 30
Conector de acero.
Cierre automático
y bloqueo manual.
Ø abertura 16 mm.



3,50€

CX-2703001200

Mosquetón 31
Conector de acero.
Con mecanismo de
cierre y bloqueo
de seguridad
automáticos.
Ø abertura 54 mm.



11€

CX-2703001700

Mosquetón KH-ALU. Aluminio.
Conector en forma de "D".
Bloqueo automático.
Desbloqueo en tres
tiempos. Ø abertura
20 mm.



11€

CX-2705002100

Bloqueador de
cuerda NAHUEL
Aluminio.
Bloqueador de
colocación frontal
para progresión
sobre cuerda fija.
Ø 8 - 13 mm.



32€

CX-2705003200

Dispositivo de descenso.
PCXPLOER
Sistema de seguridad
antipánico y función de
bloqueo gradual.



222,86€

CX-2705001100

Puño de ascenso
derecho SARYU
Aluminio. Ø de
trabajo de 8 a
13 mm.



36€

CX-2706001200

Asiento de suspensión
prolongada
Madera. 67x24 cm.
Acolchamiento en
glúteos. 3 argollas
portamateriales.
Longitud de cinta
regulable.



109€

CX-2706100130

PETATE SPORT
30 lt.



65€

CX-2705004100

PEDAL DE YUMA
Fabricado en cinta.
Regulable.
Con un maillón.

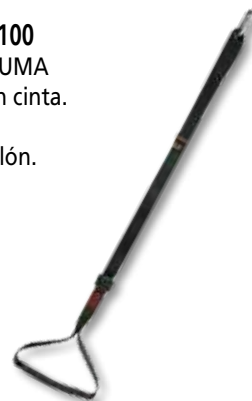

36€

CX-2707002200

Dispositivo anti-caidas retráctil
con 2 conectores. Climax 30.
Carcasa en ABS.
Absorbedor de energía.
Elemento de amarre a partir
de cinta de poliamida de 49 mm.
Longitud 2,5 m.



61,48€

CX-2707003110

10M. Dispositivo anti-caidas retráctil
con conector Climax 30.
Carcasa en ABS.
Absorbedor de energía.
Cable de acero de Ø 4,8 mm. y 10 m.
Conector Climax KH-GIRO
Ø19 mm.



277,26€

OFERTA ESPECIAL

CHAQUETA MULTIBOLSILLOS

Tallas S-M-L-XL-XXL.



F-991207
CAQUI



F-991206
MARINO



6,95€

CHALECO REFLECTANTE

Ref.:CHLXLA

Amarillo.
100% poliéster.
Cierre velcro.
Talla XL.

Alta
visibilidad



2,29€

PANTALÓN MULTIBOLSILLOS

Tallas XS-S-M-L-XL-XXL.



F-991202
CAQUI



F-991200
AZULINA



6,95€



**Profesionales
trabajando para
Profesionales**

Consulta nuestros catálogos
generales en nuestra web:

www.grupocevik.es



IVA NO INCLUIDO.

La empresa no se hace responsable de posibles erratas tipográficas o de impresión en las especificaciones técnicas o en los precios mostrados en este folleto.

Fecha de validez hasta el
30 de Abril de 2022

